

Potain Igo T 130

Product Guide



Features

- 8000 kg (17,637 lb) maximum capacity
- 1400 kg (3086 lb) capacity at 50 m (164 ft)
- 50 m (164 ft) maximum operating hook radius
- 37,3 m (122 ft) maximum tip hook height with jib horizontal
- 61 m (200 ft) maximum hook height with 50 m (164 ft) jib set at 30°
- Variable height lattice mast from 19,3 m (63 ft) to 37,3 m (122 ft) with optional mast inserts

Features



Mast inserts

Increase your working height by up to 15 m (49 ft) with optional mast inserts. Each insert is 6 m (20 ft) and provides the operator with additional heights under hook.



Cab

Two cabs are available for the Igo T 130: the Ultra View cab is equipped with integrated controls and provides maximum operator comforts; the Cab 800 provides operators with an areal view and offers basic comforts.

SmartCom technology

SmartCom is an embedded control system in CAN bus network which is based on a man-machine interface located in the control panel. This electronic system offers various functionalities which make putting the crane into service, as well as controlling the safety devices, faster and easier and makes crane maintenance easier than ever.



UL/CSA control panel

The Igo T 130 is equipped with a UL/CSA listed main electrical panel for the North American market.



Central lubrication

Prolong the life of the slewing ring with our automated lubrication system. This centralized system allows the technician to program a specific grease application from a large reservoir ensuring the proper slewing ring gear and bearing lubrication on the job site.

Contents

Specifications	4
Transport	5
Weights	6
Dimensions	7
Crane profile	8
Load charts	9
Mechanisms	10
Metric dimension	11
Metric crane profile	12
Metric load charts	13
Metric mechanisms	14
Symbols glossary	15

Specifications



Jib

47 m (154 ft) radius standard offsettable lattice jib; 50 m (164 ft) radius jib is optional. Two (2) tie bar lines with adjustable lengths allow jib to be offset up to 30°. Opening and aligning are carried out automatically by four (4) hydraulic cylinders.



Mast

Telescoping lattice mast raised by an auxiliary winch and pulley block. Hook heights of 19,3 m (63 ft) and 22,3 m (73 ft) achievable with standard mast. 360° rotation possible during raising sequence.



*Optional mast inserts

Three (3) 6 m (20 ft) mast inserts available to reach a maximum horizontal hook height of 37,3 m (122 ft). Increasing mast height with one insert provides hook heights of 25,3 m (83 ft) and 28,3 m (93 ft); second mast insert provides hook heights of 31,3 m (103 ft) and 34,3 m (113 ft); third mast insert provides a hook height of 37,3 m (122 ft).



Chassis

Outriggers swing and lock into position. 5 m (16.4 ft) square outrigger spread with 4 m (13.1 ft) maximum turning radius. Outrigger pads are stowed on the crane during transport (600 mm x 600 mm [23.6 in x 23.6 in]).



*Ballast

Ballast requirement for the crane consists of, at minimum, eleven (11) slabs each weighing 4050 kg (8929 lb). An additional slab is required in some raised jib configurations.



Electrical requirement

480 volt, 60 Hz measured at the turntable. Power Control allows for a reduction in power supply for a proportional reduction in hoisting speed. Earth rod and electric cable stored on the crane during transport.



Reeving

SM/DM block for 2 (SM) or 4-part line (DM). Manual removal of one pin to change between SM and DM.



Anemometer

Electronic wind speed meter to alert the operator of wind speed conditions. Provides selective display on the radio remote. Crane can be operated in wind speeds up to 72 km/h (45 mph) and weather vane in winds up to 150 km/h (93 mph).



Controls

Wireless remote control provides information to the operator about wind speed, radius, hook height, load, and moment. Lights and buzzers alert the operator when nearing limits of operation. Battery charger and extra battery are provided with crane.

Auxiliary push button tethered remote ensures continual operation in case of battery or other malfunction of the wireless remote control. Optional tethered remote control ensures continual operation with same functions and ergonomics as standard wireless remote control.



Swing

RVF 161 Optima+ slewing mechanism with maximum swing speed of 0.8 rpm. Progressive control of speed with counter-slewing possible, anti-load swinging system makes aligning the load and jib easier. Multiple rpm speeds possible depending upon parameter selected.



Hoist

33 LVF 20 Optima: 29.5 HP variable frequency hoist with 2 t (2.2 USt) line pull. Progressive speed change according to the accelerating or decelerating ramps. Optima allows the hoist to adapt its speed to the weight of the load.



Trolley

5 DVF 5: 5.4 HP variable frequency hoist with 500 kg (1102 lb) line pull. Progressive speed change according to acceleration or deceleration ramps controlled by the frequency converter.



Hydraulic equipment

Hydraulic cylinders are used for unfolding the mast and jib. All actions are carried about by the remote control.



*Optional transport axle sets

Axle sets are available for both jobsite and highway applications. Jobsite axles are rated for 25 km/h (15.5 mph) and highway axles are rated for 80 km/h (50 mph).

*Optional equipment

- * STANDARD NORTH AMERICAN SPECIFICATION: 50 m (164 ft) jib radius, includes offsettable jib, 3 mast inserts, Dialog Wind, cold weather kit and 12 counterweight slabs.
- * Offsettable jib
- * Mast inserts 6 m (20 ft)
- * Electric slip ring
- * Central lubrication
- * Ultra View cab
- * Cab 800
- * Cold weather kit
- * Top Zone
- * Top Tracing II
- * Transport axles and kits

*Denotes optional equipment
**Requires optional anemometer

SL122/S215M 25 km/h / 15.5 mph

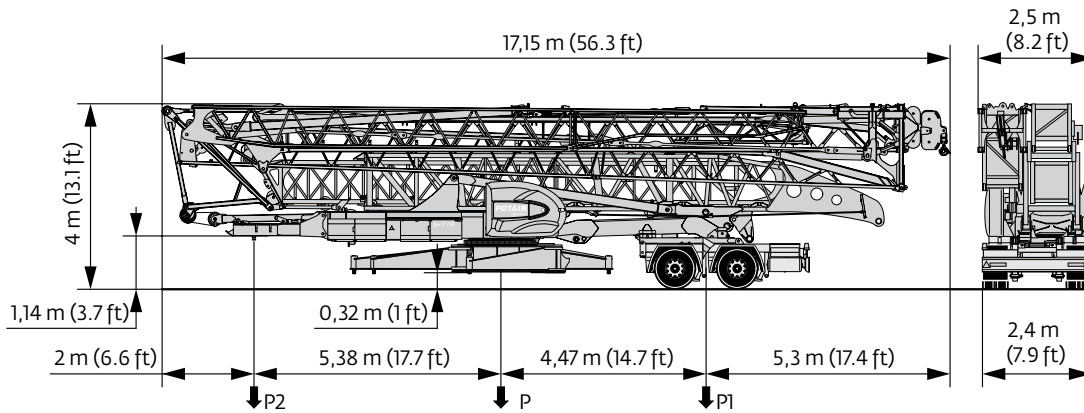

SJ122/J215M 80 km/h / 50 mph

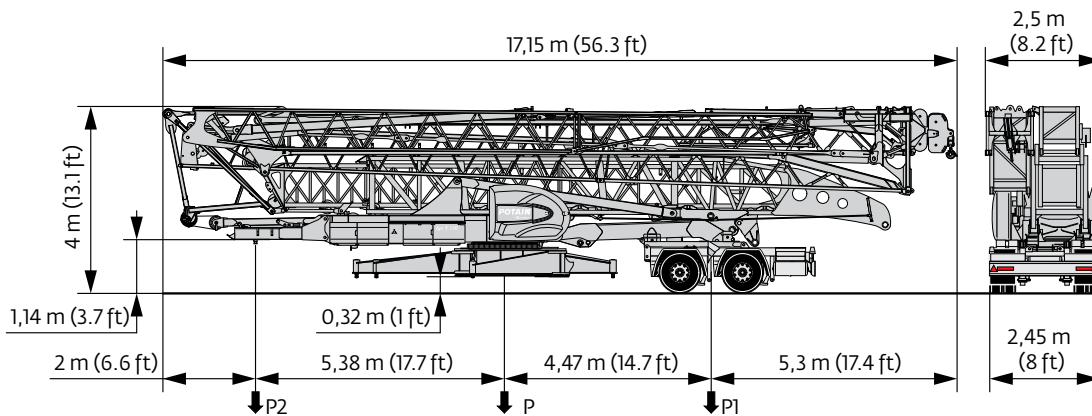

NOTE: Dimensions and weights may vary due to manufacturing tolerances.

Weights

North American Highway Axle

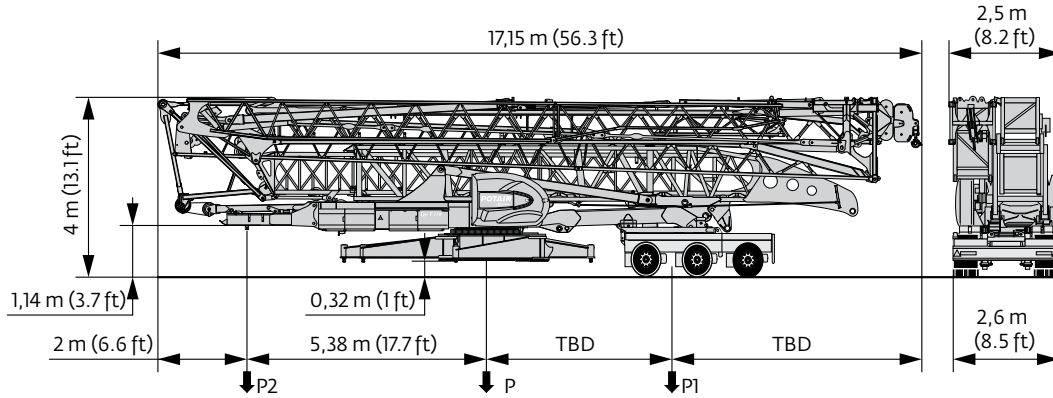

*Other axle sets are available.

Chassis data (in transport position)

	SL122/S215M 25 km/h (15.5 mph)		SJ122/J215M 80 km/h (50 mph)		North American Highway Axle	
	meters	(feet)	meters	(feet)	meters	(feet)
Overall length	17,15	56.3	17,15	56.3	17,15	56.3
Overall height	4	13.1	4	13.1	4	13.1
Overall width	2,5	8.2	2,5	8.2	2,6	8.5
Overhang	5,3	17.4	5,3	17.4	TBA	TBA

Weights

Crane weight less counterweight:		27 960 kg		61,641 lb
Counterweight for operation (12 slabs):		48 600 kg		107,145 lb
Crane with counterweight:		76 560 kg		168,786 lb

	Crane with transport equipment				North American Highway Axle	
	SL122/S215M 25 km/h (15.5 mph)		SJ122/J215M 80 km/h (50 mph)		kilograms	(pounds)
In transport with no counterweight:						
Gross (P)	30 100	66,359	30 000	66,139	TBA	TBA
Rear (P1)	19 300	42,549	19 200	42,329	TBA	TBA
Front (P2)	10 800	23,810	10 800	23,810	TBA	TBA

NOTE: Dimensions and weights may vary due to manufacturing tolerances.

Dimensions

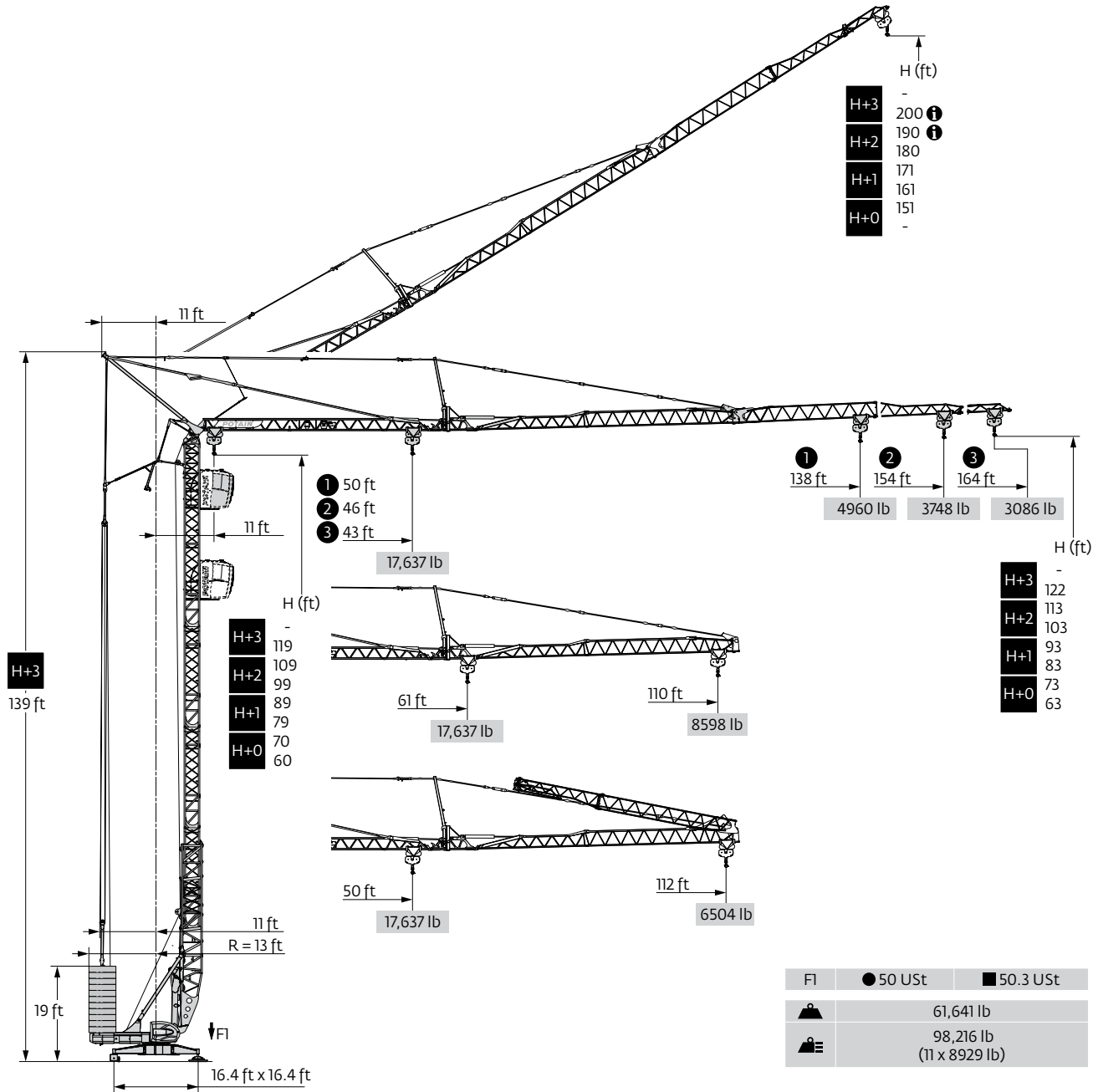

❗ For these heights, the load charts are reduced.

THIS CHART IS ONLY A GUIDE AND SHOULD NOT BE USED TO OPERATE THE CRANE.

Crane profile

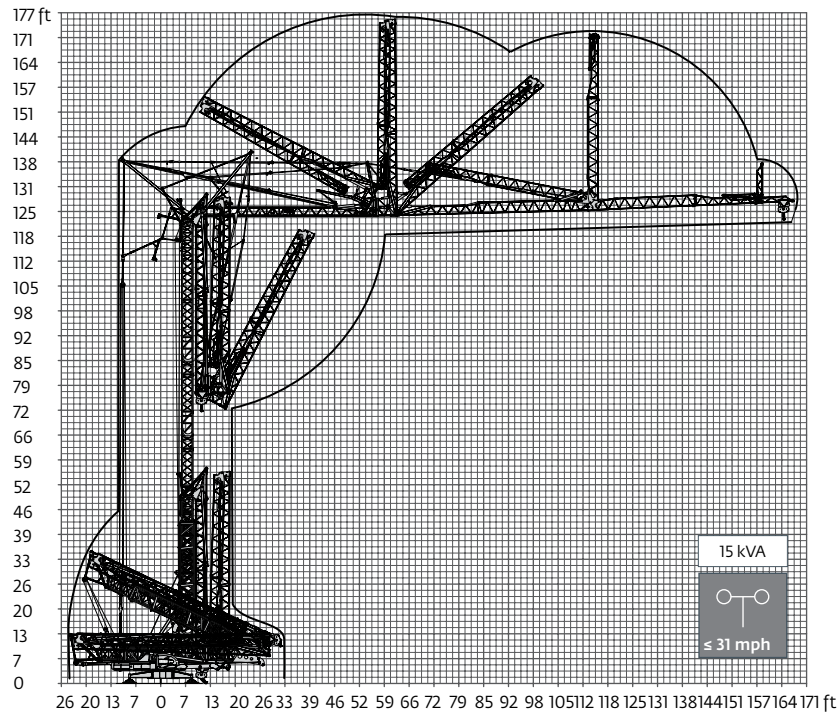

Jib raised 30°

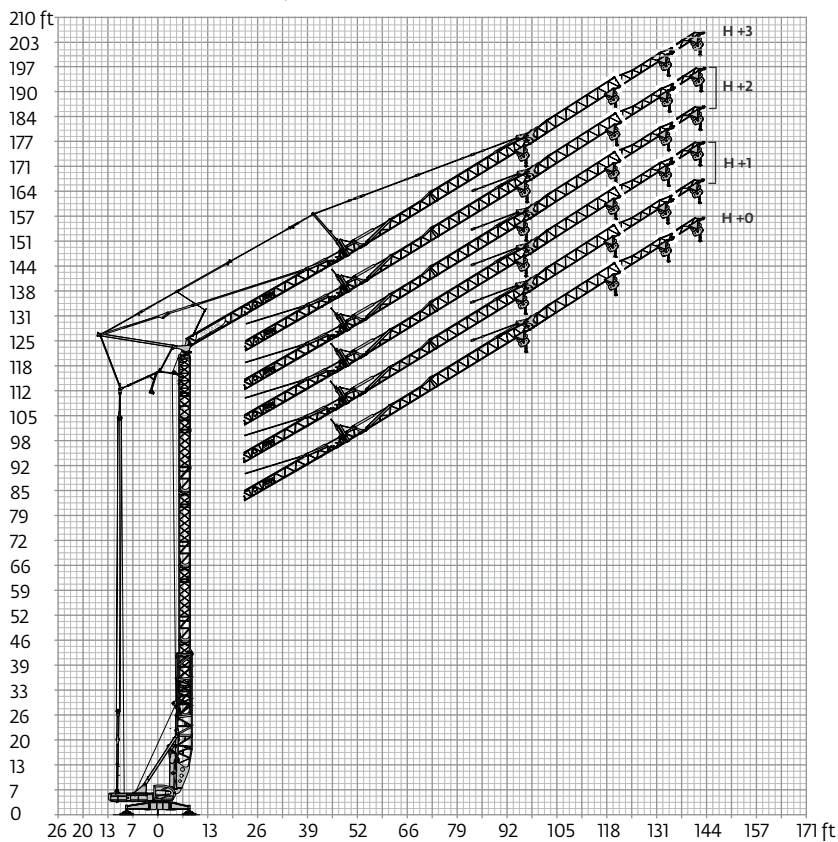

Load charts

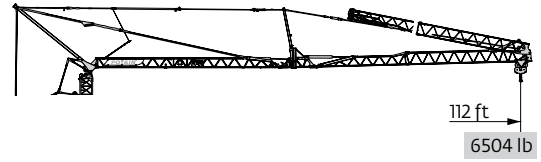
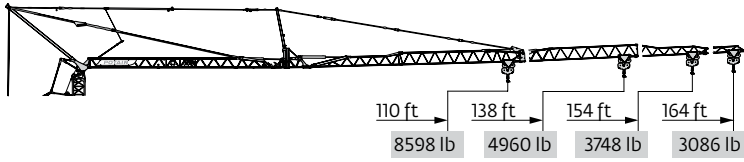

164 ft	11	▶	43	46	52	59	66	72	74	75	79	85	92	98	105	112	118	125	131	138	144	151	157	164	ft	
▲▲▲▲			17,637	16,314	13,669	11,905	10,362	9259	-	8598	8157	7496	6834	6173	5732	5291	4850	4519	4189	3968	3748	3527	3307	3086	lb	
									8818	8598	8157	7496	6834	6173	5732	5291	4850	4519	4189	3968	3748	3527	3307	3086	lb	
154 ft	11	▶	46	49	52	59	66	72	79	80	82	85	92	98	105	112	118	125	131	138	144	151	154	ft		
▲▲▲▲			17,637	16,314	14,991	13,007	11,244	10,141	9039	-	8598	8157	7496	6834	6283	5732	5401	4960	4630	4409	4079	3858	3748		lb	
										8818	8598	8157	7496	6834	6283	5732	5401	4960	4630	4409	4079	3858	3748		lb	
138 ft	11	▶	50	52	59	66	72	79	82	85	88	89	92	98	105	112	118	125	131	138				ft		
▲▲▲▲			17,637	16,755	14,330	12,566	11,244	10,141	9480	9039	-	8598	8378	7716	7055	6504	6063	5622	5291	4960					lb	
										8818	8598	8378	7716	7055	6504	6063	5622	5291	4960						lb	
110 ft	11	▶		61	66	72	79	82	85	89	92	98	105	108	110										ft	
▲▲▲▲				17,637	16,094	14,330	13,007	12,346	11,685	11,244	10,803	9921	9039	-	8598											lb
														8818	8598										lb	

164 ft	11	▶		50	52	59	66	72	79	85	88	92	98	105	112										ft	
▲▲▲▲				17,637	16,755	14,330	12,566	11,244	10,141	9039	-	8378	7716	7055	6504											lb
											8818	8378	7716	7055	6504											lb

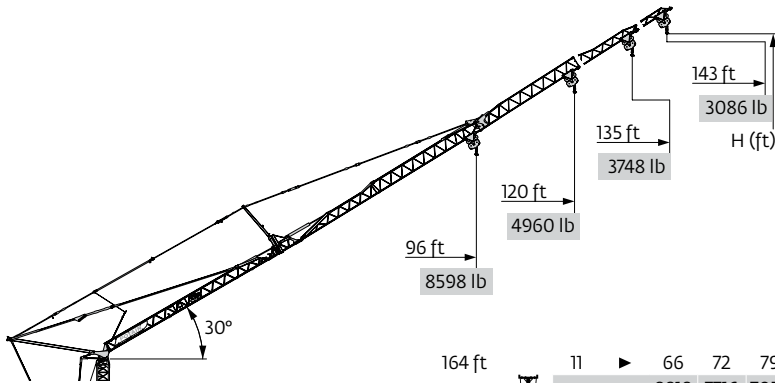

▲▲▲▲		164 ft	154 ft	138 ft	110 ft
H+3	ⓘ	-	-	-	-
H+2	ⓘ	200	195	186	171
		180	175	166	151
H+1		171	165	156	141
H+0		151	146	137	122
		-	-	-	-

164 ft	11	▶	66	72	79	85	92	98	105	112	118	125	131	138	143	ft
▲▲▲▲			8818	7716	7055	6283	5732	5181	4740	4409	4079	3748	3527	3307	3086	lb
154 ft	11	▶	70	72	79	85	92	98	105	112	118	125	135			ft
▲▲▲▲			8818	8598	7716	6834	6283	5732	5291	4850	4519	4189	3748			lb
138 ft	11	▶		77	85	92	98	105	112	120						ft
▲▲▲▲				8818	7716	7055	6504	5952	5512	4960						lb
110 ft	11	▶					94	96								ft
▲▲▲▲							8818	8598								lb

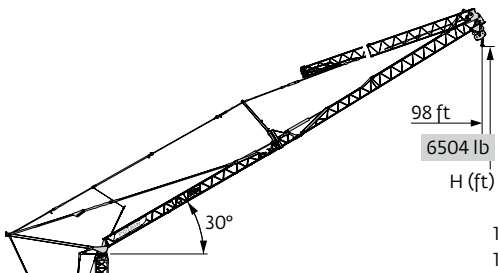







164 ft	11	▶		77	79	85	92	98																		ft	
154 ft																											ft
138 ft	11	▶		8818	8598	7716	7055	6504																			lb



▲▲▲▲		164 ft	154 ft	138 ft
H+3	ⓘ	-	172	162
H+2	ⓘ	152	142	133
H+1		123		
H+0		-		

ⓘ For these heights, the load charts are reduced.

THIS CHART IS ONLY A GUIDE AND SHOULD NOT BE USED TO OPERATE THE CRANE.





Mechanisms

400 V - 50 Hz 480 V - 60 Hz													hp	kW
	33 LVF 20 Optima	fpm	10	52	89	177	213	5	26	44	89	107	29.5	22
		lb	8818	8818	8818	4409	2205	17637	17637	17637	8818	4409		
	5 DVF 5	fpm	49 - 98 - 180 (8818 → 17,637 lb) 49 - 98 - 230 (1102 → 8818 lbg) 49 - 98 - 328 (0 → 1102 lb)									5.4	4	
	RVF 161 Optima+	rpm	0 → 0.8									6	4.5	
	TVF 324	fpm	82									2 x 4	2 x 3	

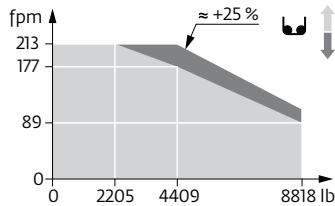
 IEC 60204-32	 kVA
400 V (+10% -10%) 50 Hz 480 V (+6% -10%) 60 Hz	35 → 20 kVA 

33 LVF 20 Optima



-  Hoisting
-  Trolleying
-  Slewing
-  Traveling

Metric dimensions

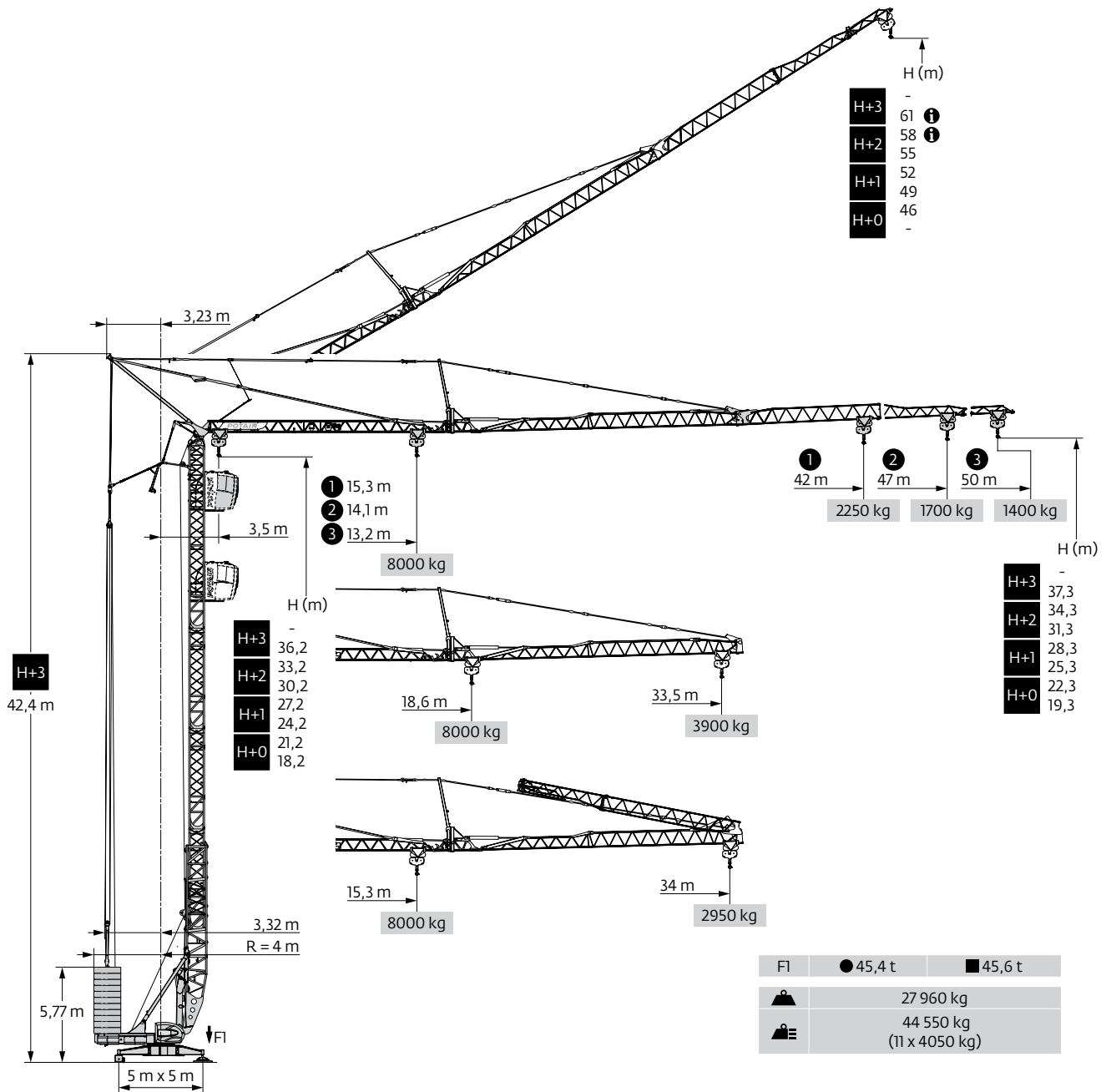

ⓘ For these heights, the load charts are reduced.

THIS CHART IS ONLY A GUIDE AND SHOULD NOT BE USED TO OPERATE THE CRANE.

Metric crane profile

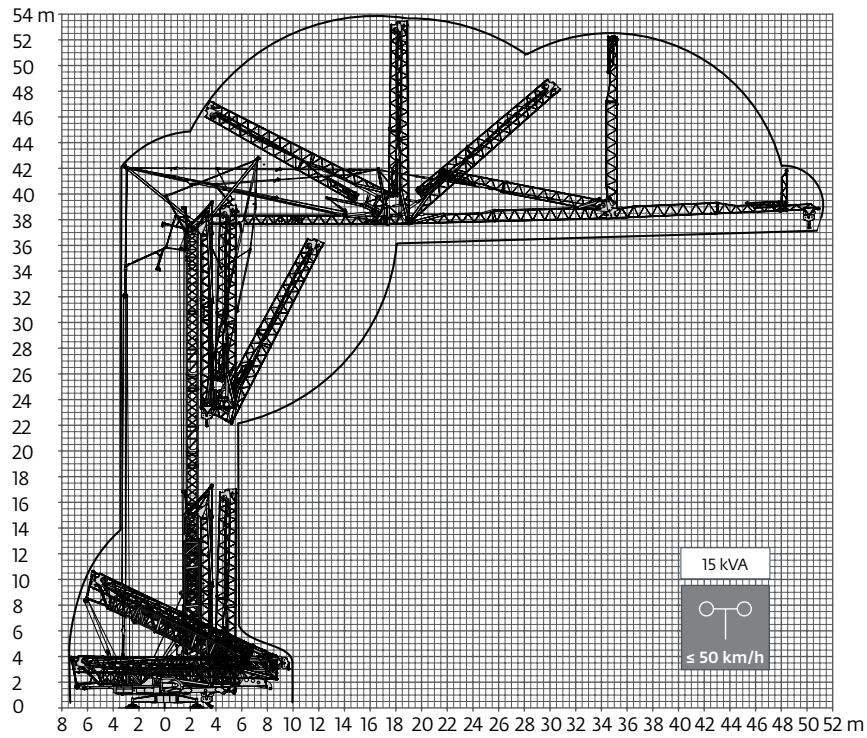

Jib raised 30°

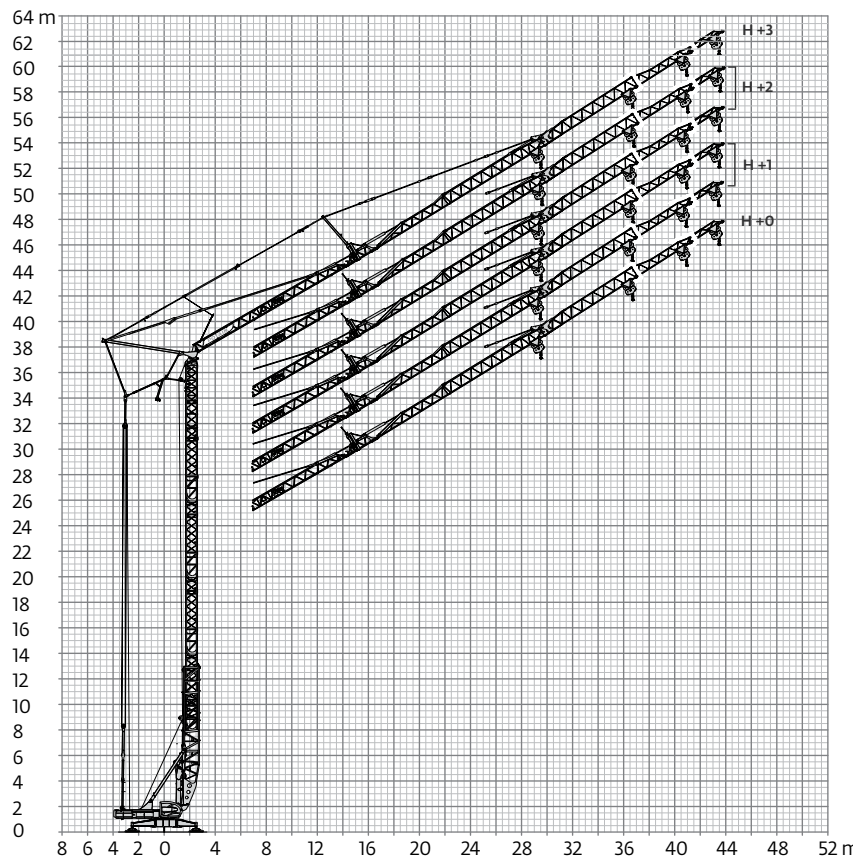

THIS CHART IS ONLY A GUIDE AND SHOULD NOT BE USED TO OPERATE THE CRANE.

The individual crane's load chart, operating instructions and other instructional plates must be read and understood prior to operating the crane.

Metric load charts

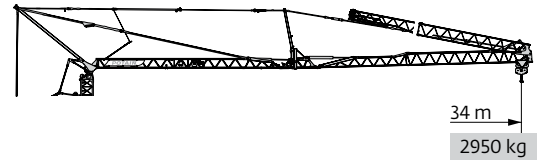
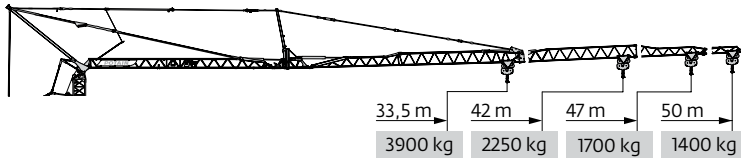

50 m	3,5	▶	13,2	14	16	18	20	22	22,7	23	24	26	28	30	32	34	36	38	40	42	44	46	48	50	m
▲▲▲▲	▶		8000	7400	6200	5400	4700	4200	-	3900	3700	3400	3100	2800	2600	2400	2200	2050	1900	1800	1700	1600	1500	1400	kg
▲▲▲▲	▶								4000	3900	3700	3400	3100	2800	2600	2400	2200	2050	1900	1800	1700	1600	1500	1400	kg
47 m	3,5	▶	14,1	15	16	18	20	22	24	24,4	25	26	28	30	32	34	36	38	40	42	44	46	47	m	
▲▲▲▲	▶		8000	7400	6800	5900	5100	4600	4100	-	3900	3700	3400	3100	2850	2600	2450	2250	2100	2000	1850	1750	1700	kg	
▲▲▲▲	▶									4000	3900	3700	3400	3100	2850	2600	2450	2250	2100	2000	1850	1750	1700	kg	
42 m	3,5	▶	15,3	16	18	20	22	24	25	26	26,7	27	28	30	32	34	36	38	40	42					m
▲▲▲▲	▶		8000	7600	6500	5700	5100	4600	4300	4100	-	3900	3800	3500	3200	2950	2750	2550	2400	2250					kg
▲▲▲▲	▶									4000	3900	3800	3500	3200	2950	2750	2550	2400	2250					kg	
33,5 m	3,5	▶	18,6	20	22	24	25	26	27	28	30	32	32,8	33,5									m		
▲▲▲▲	▶		8000	7300	6500	5900	5600	5300	5100	4900	4500	4100	-	3900									kg		
▲▲▲▲	▶											4000	3900									kg			

50 m																								
47 m	3,5	▶	15,3	16	18	20	22	24	26	26,7	28	30	32	34										m
42 m			8000	7600	6500	5700	5100	4600	4100	-	3800	3500	3200	2950										kg
▲▲▲▲										4000	3800	3500	3200	2950										kg

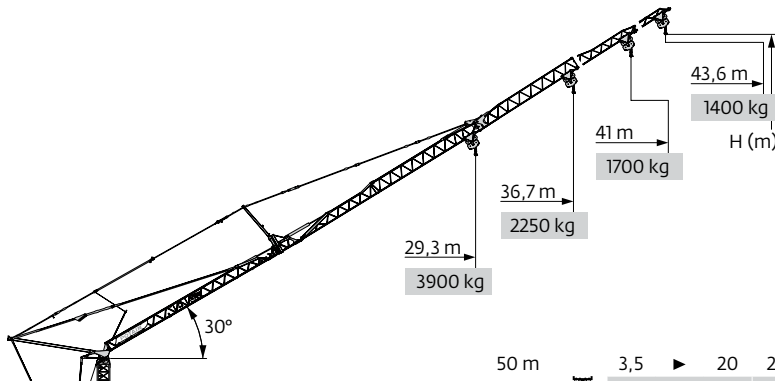

▲▲▲▲		50 m	47 m	42 m	33,5 m
H+3	ⓘ	-	-	-	-
H+2	ⓘ	61	59,4	56,7	52,1
H+1		55	53,4	50,7	46,1
H+0		52	50,4	47,7	43,1
		49	47,4	44,7	40,1
		46	44,4	41,7	37,1
		-	-	-	-

50 m	3,5	▶	20	22	24	26	28	30	32	34	36	38	40	42	43,6	m
▲▲▲▲	▶		4000	3500	3200	2850	2600	2350	2150	2000	1850	1700	1600	1500	1400	kg
47 m	3,5	▶	21,4	22	24	26	28	30	32	34	36	38	41			m
▲▲▲▲	▶		4000	3900	3500	3100	2850	2600	2400	2200	2050	1900	1700			kg
42 m	3,5	▶			23,5	26	28	30	32	34	36,7					m
▲▲▲▲	▶				4000	3500	3200	2950	2700	2500	2250					kg
33,5 m	3,5	▶					28,8	29,3								m
▲▲▲▲	▶						4000	3900								kg

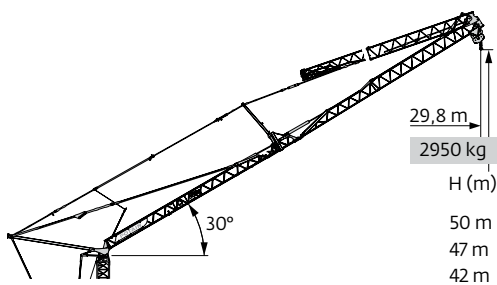









▲▲▲▲		50 m
		47 m
		42 m
H+3	ⓘ	-
H+2	ⓘ	52,4
		49,4
		46,4
H+1		43,4
		40,4
H+0		37,4
		-

ⓘ For these heights, the load charts are reduced.

THIS CHART IS ONLY A GUIDE AND SHOULD NOT BE USED TO OPERATE THE CRANE.



Metric mechanisms

400 V - 50 Hz 480 V - 60 Hz												ch - PS hp	kW	
	33 LVF 20 Optima	m/min	3,2	16	27	54	65	1,6	8	13,5	27	32,5	29,5	22
		kg	4000	4000	4000	2000	1000	8000	8000	8000	4000	2000		
	5 DVF 5	m/min	15 - 30 - 55 (4000 → 8000 kg) 15 - 30 - 70 (500 → 4000 kg) 15 - 30 - 100 (0 → 500 kg)									5,4	4	
	RVF 161 Optima+	tr/min U/min rpm	0 → 0,8									6	4,5	
	TVF 324	m/min	25									2 x 4	2 x 3	

 IEC 60204-32	
400 V (+10% -10%) 50 Hz 480 V (+6% -10%) 60 Hz	35 → 20 kVA 

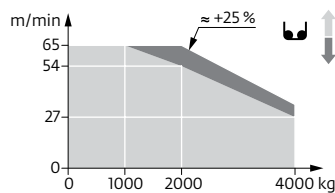
33 LVF 20 Optima



	Hoisting
	Trolleying
	Slewing
	Traveling

Symbols glossary



Jib



Mast



Anemometer



Swing



Outrigger



Chassis



Hydraulic equipment



Controls



Electrical requirement



Ballast



Transport axle



Ballasting derrick



Reeving



Hoist



Trolley

Manitowoc Cranes

Regional headquarters

Americas

Manitowoc, Wisconsin, USA

Tel: +1 920 684 6621

Fax: +1 920 683 6277

Shady Grove, Pennsylvania, USA

Tel: +1 717 597 8121

Fax: +1 717 597 4062

Europe, Middle East, Africa

Ecully, France

Tel: +33 (0)4 72 18 20 20

Fax: +33 (0)4 72 18 20 00

China

Shanghai, China

Tel: +86 21 6457 0066

Fax: +86 21 6457 4955

Greater Asia-Pacific

Singapore

Tel: +65 6264 1188

Fax: +65 6862 4040

Regional offices

Americas

Brazil

Alphaville

Mexico

Monterrey

Chile

Santiago

Europe, Middle East,

Africa

Czech Republic

Netvorice

France

Baudemont

Cergy

Decines

Germany

Langenfeld

Hungary

Budapest

Italy

Lainate

Netherlands

Breda

Poland

Warsaw

Portugal

Baltar

Russia

Moscow

South Africa

Johannesburg

U.A.E.

Dubai

U.K.

Buckingham

China

Beijing

Chengdu

Guangzhou

Xian

Greater Asia-Pacific

Australia

Brisbane

Melbourne

Sydney

India

Chennai

Delhi

Hyderabad

Pune

Korea

Seoul

Philippines

Makati City

Singapore

Factories

Brazil

Passo Fundo

China

TaiAn

Zhangjiagang

France

Charlieu

Moulins

Germany

Wilhelmshaven

India

Pune

Italy

Niella Tanaro

Portugal

Baltar

Fânzeres

Slovakia

Saris

USA

Manitowoc

Port Washington

Shady Grove

This document is non-contractual. Constant improvement and engineering progress make it necessary that we reserve the right to make specification, equipment, and price changes without notice. Illustrations shown may include optional equipment and accessories and may not include all standard equipment.