

# TMS9000-2

## Preliminary Product Guide

ASME B30.5  
Imperial 85%



### Features

- 100 t (115 USt)
- 11,2 m - 51,6 m (36 ft -169 ft) six-section greaseless MEGAFORM™ boom
- TWIN-LOCK™ boom pinning system
- Several 10,5 m - 17,6 m (34.5 ft - 57.6 ft) bi-fold swingaway extension options and an 8 m (26 ft) insert
- Crane Control System (CCS)
- Tilt superstructure cab
- Up to 22 000 kg (48,500 lb) counterweight with hydraulic removal system

# GROVE TMS9000-2

The TMS9000-2 sets a new standard for truck mounted cranes; with the strongest load charts and the longest boom all at a lighter gross vehicle weight for superior roadability than any other truck crane in its class.

## Features

### > MEGAFORM™ boom

The Grove MEGAFORM™ boom shape eliminates weight and increases capacity compared to conventional shapes. The simplified TWIN-LOCK™ boom pinning system automatically pins the sections in position using two horizontal large diameter pins. A single cylinder inside the boom reduces weight which has been used elsewhere to strengthen the machine.

### > Counterweight

Up to 22 000 kg (48,500 lb) of counterweight can be power installed and removed from the superstructure cab — allowing for easy transport to and from the job site. Wing weights are interchangeable with previous model.

### > Control system

Crane functions are controlled by Crane Control System (CCS). CCS offers a user-friendly interface, two full graphic displays mounted vertically for easier viewing and a jog dial for easier navigation and data input. The system allows the electronic controllers to be reprogrammed by the operator for specific speed and reaction. Parts commonality across Grove, Manitowoc and Potain product lines enhances operator familiarization and serviceability.

### > Outriggers

Two-stage outriggers provide four position settings - 0%, 57%, 79%, and 100%.

### > Optional power luffing extension

For improved up-and-over reach, a power luffing extension is available on the TMS9000-2. It is hydraulically offsettable from the superstructure cab, 0° to 45°. Additional extensions are also available including integrated heavy duty and manually offsettable options.

### > CraneSTAR is an exclusive and innovative crane asset management system

that helps improve your profitability and reduce costs by remotely monitoring critical crane data. Visit [www.cranestar.com](http://www.cranestar.com) for more information.



**CraneSTAR**®

## Job site benefits

- Multiple ladders on the carrier make accessing the crane easy
  - Standard hydraulic tilt cab 0° - 20° for exceptional visibility and operator comfort while working with long boom, inserts, and swingaway
- TWINLOCK™ boom pinning system helps maximize the crane's load chart capacity by eliminating weight inside the extended boom
- Four position outriggers provide more flexibility for setup in congested work environments
- Traction control provides improved traction on the job site
- Available hydraulically offsettable 10,5 m - 17,6 m (34.5 ft - 57.6 ft) bi-fold 0° - 45° offset capability swingaway. This option is conveniently operated inside the cab and is easily stowed and erected using hydraulics
- Available hydraulically offsettable two-sheave 10,5 m - 17,6 m (34.5 ft - 57.6 ft) integrated heavy duty bi-fold swingaway for tilt-up work
- Standard wireless rigging remote enables convenient setup



**Manitowoc Crane Care when you need it.**  
The assurance of the world's most advanced crane service and support to get you back to work fast.



**Manitowoc Finance helps you get right to work generating profits for your business.**  
Financial tools that help you capitalize on opportunity with solutions that fit your needs.

# Contents

Dimensions	5
Counterweight	6
Travel proposals	7
Load handling	9
Working range - Main boom	10
Load charts - Main boom	11
Working range - Main boom and manually offsettable extension	16
Load charts - Main boom and manually offsettable extension	17
Working range - Main boom and integrated heavy duty jib	18
Load charts - Main boom and integrated heavy duty jib	19
Specifications	20
Symbols glossary	22

# Dimensions

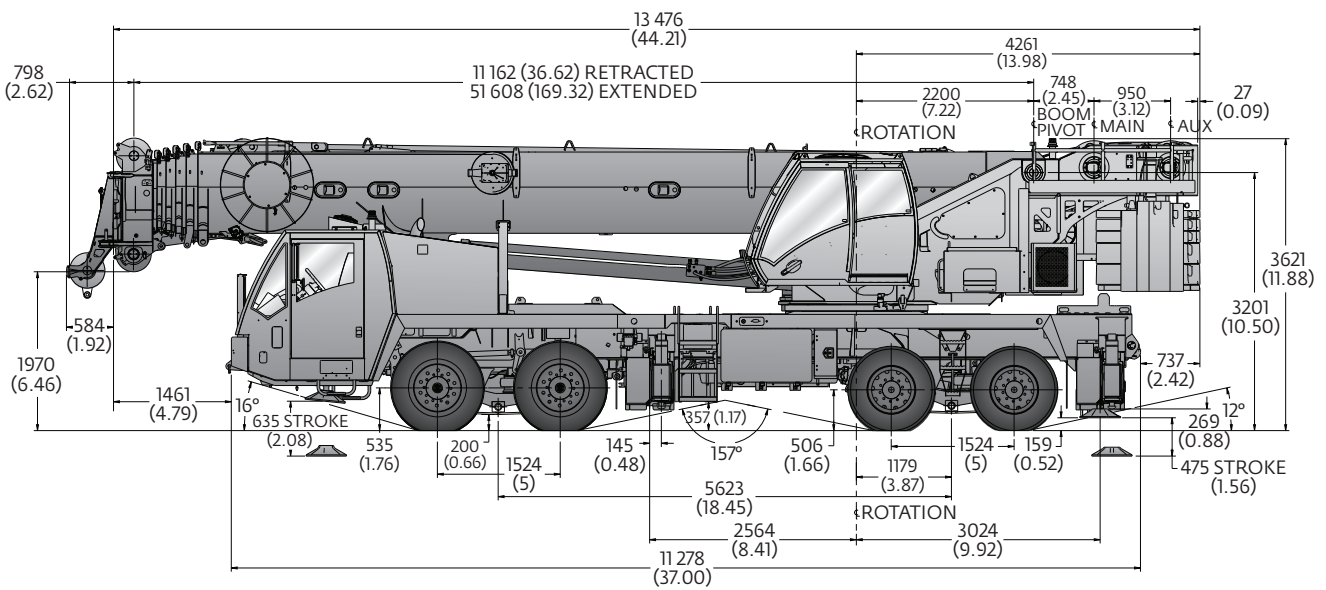
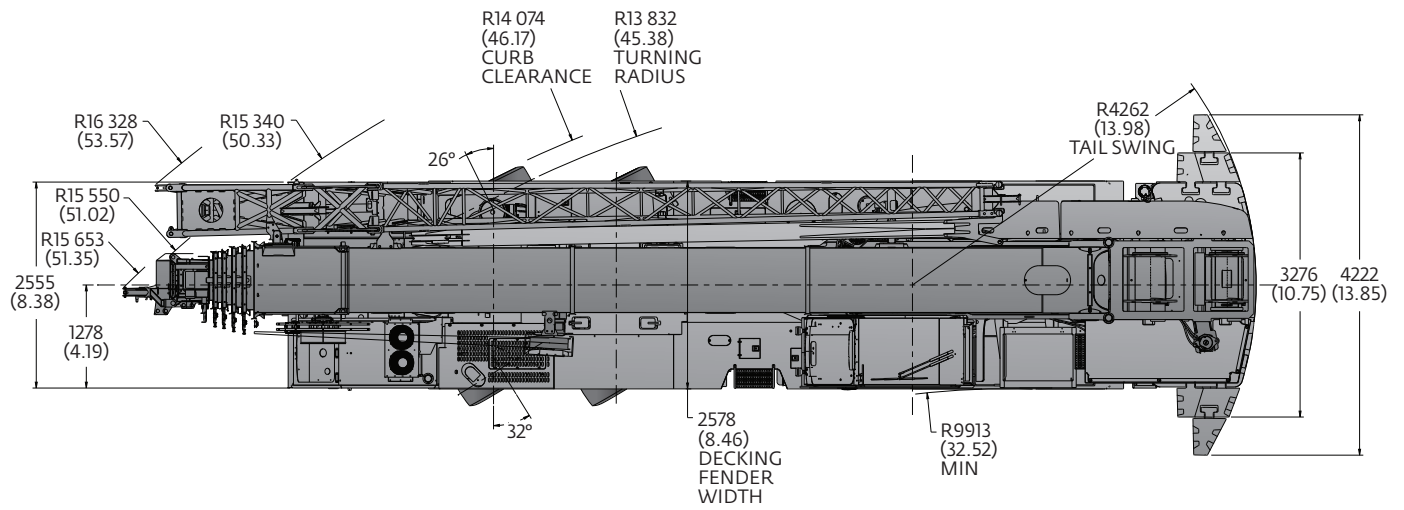

*Dimensions shown in mm (ft)*

# Counterweight

## Counterweight configurations

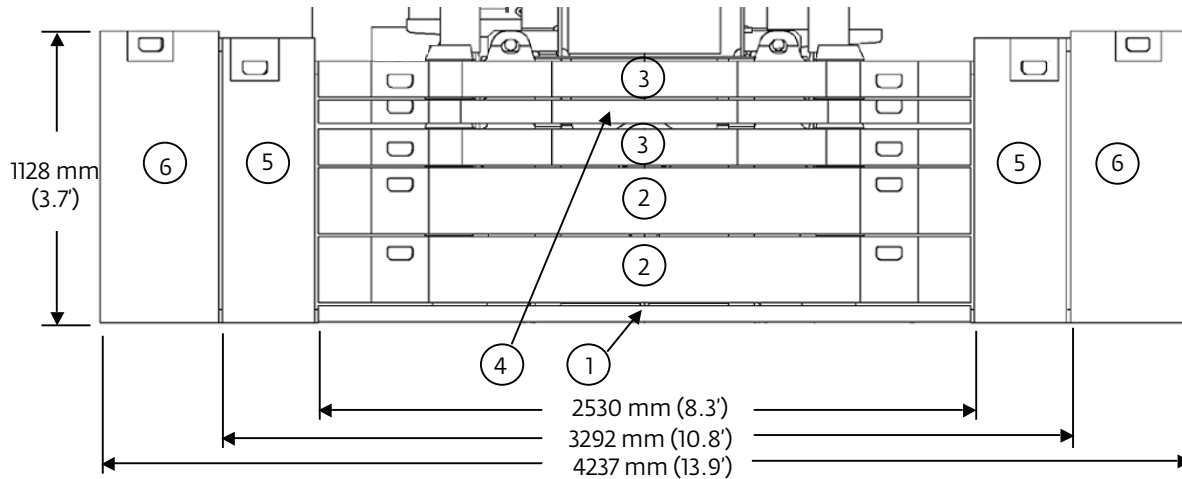

- 1. 1361 kg (3000 lb) baseplate
- 2. 4536 kg (10,000 lb) stackable
- 3. 2268 kg (5000 lb) pinned or stackable
- 4. 1361 kg (3000 lb) pinned or stackable
- 5. 1814 kg (4000 lb) wing
- 6. 1021 kg (2250 lb) wing

Load chart configurations						
	1	2	3	4	5	6
0						
2722 kg (6000 lb)	X			X		
4990 kg (11,000 lb)	X		X	X		
7258 kg (16,000 lb)	X		2X	X		
9525 kg (21,000 lb)	X	X	X	X		
11793 kg (26,000 lb)	X	X	2X	X		
16329 kg (36,000 lb)	X	2X	2X	X		
19958 kg (44,000 lb)	X	2X	2X	X	2X	
22000 kg (48,500 lb)	X	2X	2X	X	2X	2X

# Travel proposals

## Boom over front

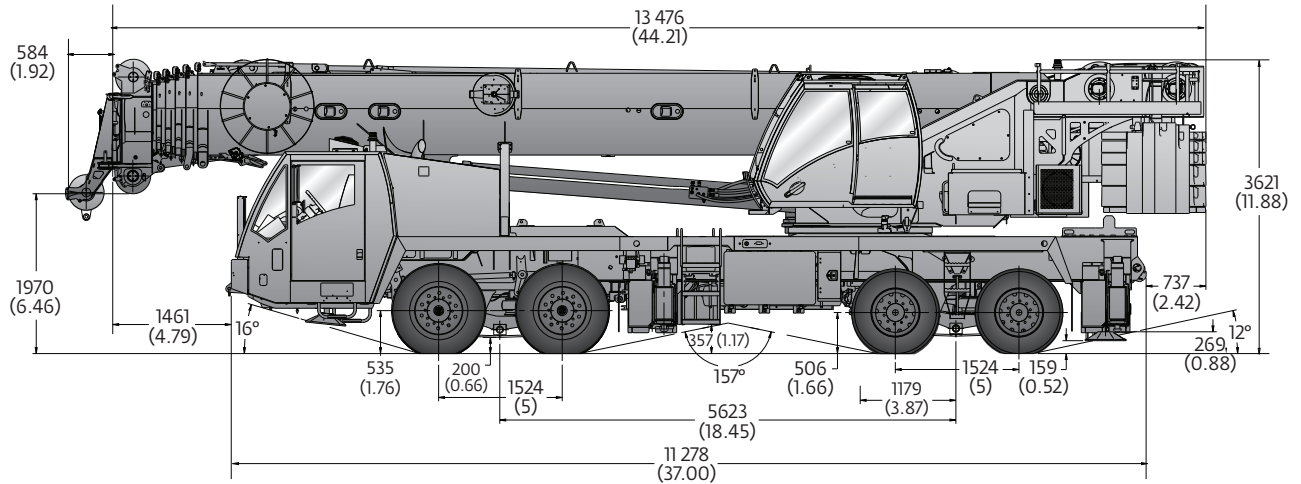

Dimensions shown in mm (ft)

## Unit configuration

	Front		Rear		G.V.W.	
<b>Basic machine:</b> Includes ISX12 on-highway engine, main and auxiliary hoists with wire rope, air conditioning chassis and superstructure cabs, no counterweight and includes driver.	19 212 kg	42,356 lb	17 868 kg	38,392 lb	36 627 kg	80,748 lb
<b>Add:</b> 3000 lb counterweight on carrier deck and 3000 lb counterweight on superstructure. Total counterweight 6000 lb.	19 780 kg	43,607 lb	19 577 kg	43,160 lb	39 357 kg	86,767 lb
<b>Add:</b> 3000 lb counterweight on carrier deck and 6000 lb counterweight on superstructure. Total counterweight 9000 lb.	19 180 kg	42,285 lb	21 546 kg	47,500 lb	40 726 kg	89,786 lb
<b>Add:</b> 8000 lb counterweight on carrier deck and 8000 lb counterweight on superstructure. Total counterweight 16,000 lb.	21 132 kg	46,587 lb	21 871 kg	48,217 lb	43 003 kg	94,805 lb
Auxiliary boom nose	155 kg	342 lb	-69 kg	-152 lb	86 kg	190 lb
Manual 10,5 m to 17,6 m (34.5 ft - 57.6 ft) bi-fold swingaway (includes brackets)	1857 kg	4093 lb	-81 kg	-179 lb	1775 kg	3914 lb
Hydraulic 10,5 m to 17,6 m (34.5 ft - 57.6 ft) bi-fold swingaway (includes brackets and hose reel)	2160 kg	4762 lb	-184 kg	-405 lb	1976 kg	4357 lb
Hydraulic integrated heavy duty jib (includes brackets and hose reel)	2268 kg	5000 lb	-152 kg	-336 lb	2116 kg	4664 lb
11,0 t (12.1 USt) top-swiveling headache ball stowed	435 kg	958 lb	-140 kg	-309 lb	294 kg	648 lb
45 t (50 USt), three-sheave quick-reeving hook block at bumper	764 kg	1685 lb	-314 kg	-693 lb	450 kg	992 lb
<b>Substitute:</b> K-100™ synthetic rope in lieu of wire rope on main and auxiliary hoist	264 kg	583 lb	-952 kg	-2098 lb	-687 kg	-1515 lb
Maximum Allowable	23 224 kg	51,200 lb	27 216 kg	60,000 lb	50 440 kg	111,200 lb

# Travel proposals

## Trailing boom dolly

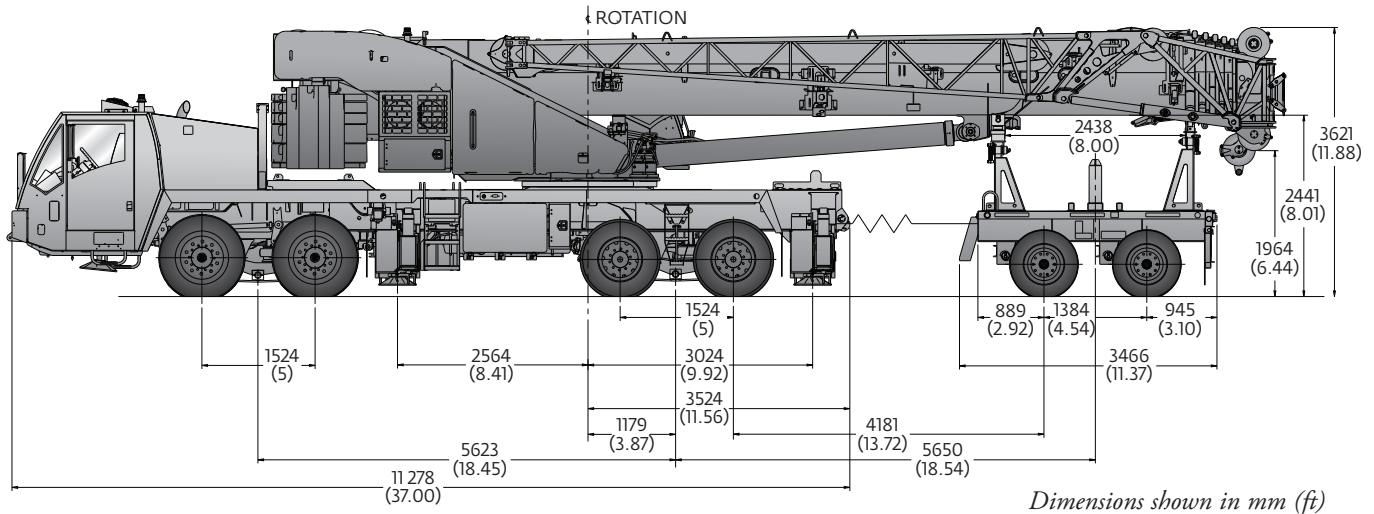

Dimensions shown in mm (ft)

## Unit configuration

	Front		Rear		Boom Dolly		G.V.W.	
<b>Typical machine:</b> Includes ISX12 on-highway engine, main and auxiliary hoists with wire rope, auxiliary boom nose, manual bifold swingaway, stowed headache ball, 45 t (50 USt) hook block hanging at boom nose, no counterweight, includes driver and 6800 lb boom dolly.	16 359 kg	36,066 lb	13 920 kg	30,688 lb	12 173 kg	26,837 lb	42 453 kg	93,592 lb
<b>Add:</b> 6000 lb counterweight on front carrier deck, 5000 lb counterweight on rear chassis counterweight carrier, 15,000 lb on boom dolly. Total counterweight 26,000 lb.	18 707 kg	41,242 lb	14 311 kg	31,551 lb	18 986 kg	41,856 lb	52 004 kg	114,649 lb
<b>Add:</b> 6000 lb counterweight on front carrier deck, 3000 lb counterweight pinned to superstructure, 5000 lb counterweight on rear chassis counterweight carrier, 20,000 lb on three-axle 9000 lb boom dolly. Total counterweight 36,000 lb.	19 866 kg	43,798 lb	17 705 kg	39,032 lb	22 260 kg	49,075 lb	59 832 kg	131 906 lb
<b>Substitute:</b> Hydraulic 10,5 m to 17,6 m (34.5 ft - 57.6 ft) bifold swingaway (includes brackets and hose reel) in lieu of the manual swingaway	-2 kg	-4 lb	1 kg	2 lb	239 kg	527 lb	236 kg	521 lb
<b>Substitute:</b> Hydraulic integrated heavy duty jib (includes brackets and hose reel) in lieu of the manual swingaway	144 kg	317 lb	96 kg	211 lb	101 kg	222 lb	341 kg	751 lb
<b>Substitute:</b> K-100™ synthetic rope in lieu of wire rope on main and auxiliary hoist	-553 kg	-1219 lb	-134 kg	-296 lb	-	-	-687 kg	-1514 lb



# Load handling

<b>Auxiliary boom nose</b>	86 kg (190 lb)
----------------------------	----------------

**Hook blocks and headache balls:**

91 t (100 USt)	658 kg (1451 lb) +
60 t (65 USt) 5-sheave	564 kg (1243 lb) +
45 t (50 USt) 3-sheave	450 kg (992 lb) +
26 t (28 USt) 1-sheave	323 kg (712 lb) +
11 t (12 USt) overhaul ball	294 kg (648 lb) +

+ Refer to rating plate for actual weight.

When lifting over extension and/or jib combinations, deduct total weight of all load handling devices reeved over main boom nose directly from swingaway or jib capacity.

Hoists	Cable specs	Permissible line pulls	Nominal cable length
Main	19 mm (3/4 in) 35x7 Class Rotation Resistant Min. Breaking Strength 38 918 kg (85,800 lb)	7784 kg (17,160 lb)	250 m (820 ft)
Main	22 mm (7/8 in) K-100™ Synthetic rope Min. Breaking Strength 31 800 kg (84,000 lb)	7620 kg (16,800 lb)	257 m (843 ft)
Auxiliary	19 mm (3/4 in) 35x7 Class Rotation Resistant Min. Breaking Strength 38 918 kg (85,800 lb)	7764 kg (17,160 lb)	177 m (581 ft)
Auxiliary	22 mm (7/8 in) K-100™ Synthetic rope Min. Breaking Strength 31 800 kg (84,000 lb)	7620 kg (16,800 lb)	184 m (604 ft)

The approximate weight of 19 mm (3/4 in) wire rope is 2.2 kg/m (1.5 lb/ft)

Hoist performance			
Wire rope layer	Hoist line pull	Drum rope capacity m (ft)	
		Available*	Total
1	10 900 kg (24,000 lb)	33,5 m (110 ft)	33,5 m (110 ft)
2	10 000 kg (22,100 lb)	36,6 m (120 ft)	70,1 m (230 ft)
3	9250 kg (20,400 lb)	39,7 m (130 ft)	109,9 m (360 ft)
4	8700 kg (19,100 lb)	42,8 m (141 ft)	152,7 m (501 ft)
5	8000 kg (17,700 lb)	45,9 m (151 ft)	198,6 m (652 ft)
6	7550 kg (16,600 lb)	49,0 m (161 ft)	247,6 m (812 ft)

\*Max lifting capacity

19 mm 35x7 Class: 7784 kg (17,160 lb)

## Working area diagram

Bold lines determine the limiting position of any load for operation within working areas indicated.

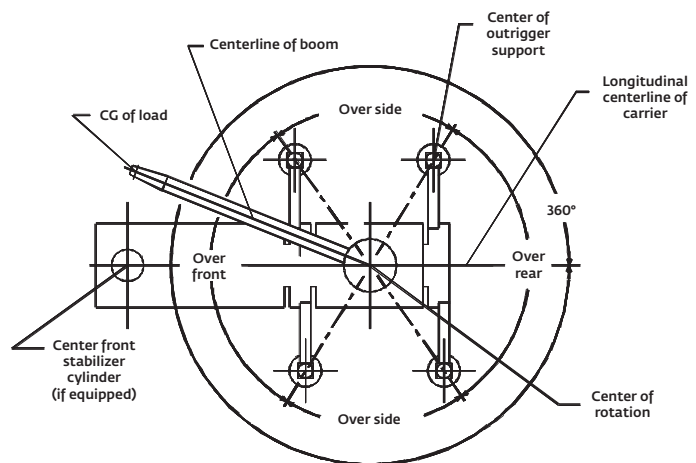

6-829-005671

THIS CHART IS ONLY A GUIDE AND SHOULD NOT BE USED TO OPERATE THE CRANE.

The individual crane's load chart, operating instructions and other instructional plates must be read and understood prior to operating the crane.

# Working range

Main boom

36.6 ft - 169.3 ft main boom

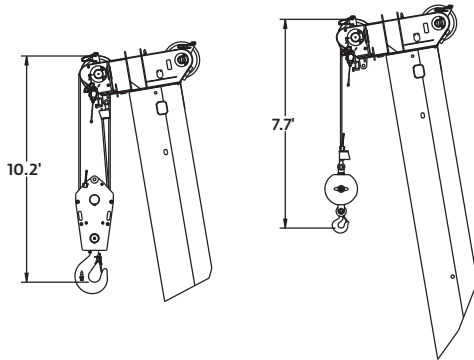
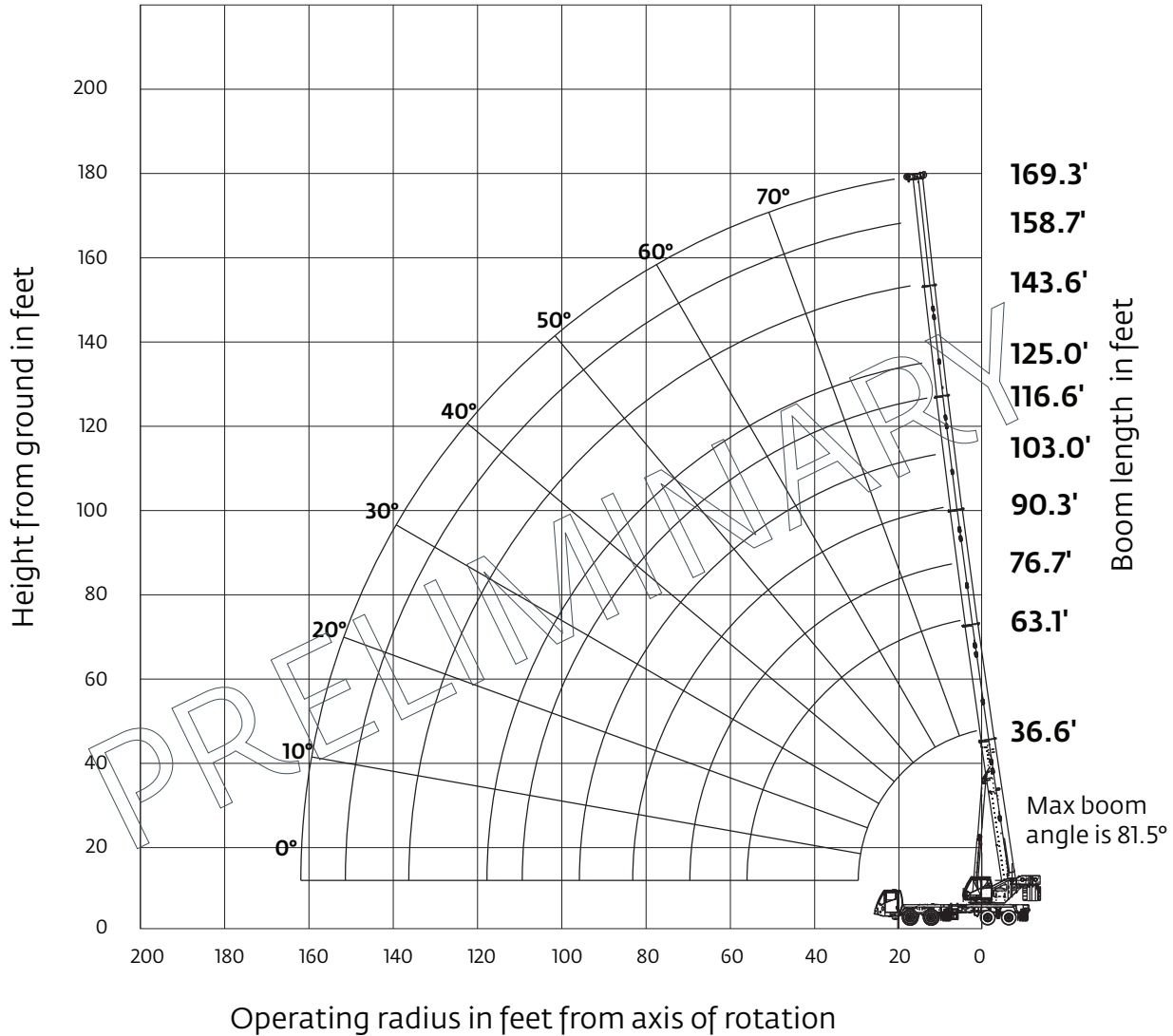

Dimensions are for the largest Grove furnished hook block and overhaul ball, with anti-two block activated.

THIS CHART IS ONLY A GUIDE AND SHOULD NOT BE USED TO OPERATE THE CRANE.

The individual crane's load chart, operating instructions and other instructional plates must be read and understood prior to operating the crane.

# Load chart

## Main boom

 36.6 ft - 169.3 ft  
Fixed lengths

 48,500 lb

 100%  
23 ft

 360°



Pounds x 1000

Feet	36.6	49.7 - 50.1	61.6 - 63.6	75.2 - 77.4	88.1-90.3	100.8 - 103.0	111.4-114.4	124.6-125.8	130.0-133.7	147.3-153.3	160.9-165.0	169.3
8.0	230,000*											
9.0	180,000	164,000	152,500	129,000								
10.0	173,500	158,000	146,000	128,500								
12.0	155,500	148,500	135,500	123,500	94,650							
15.0	134,500	135,500	123,500	114,000	94,650	75,000						
20.0	108,000	109,500	110,000	99,950	93,900	73,550	58,050	45,800	40,950			
25.0	84,850	86,450	87,050	86,650	84,150	71,000	58,050	45,800	40,950	30,050		
30.0		70,450	71,050	70,700	72,000	62,850	56,600	45,800	39,550	30,050	24,450	21,200
35.0		58,000	58,350	59,900	59,050	56,150	50,350	45,800	35,300	30,050	24,450	21,200
40.0		48,650	48,300	49,800	49,000	50,350	45,000	43,550	35,300	30,050	24,450	21,200
45.0			41,450	42,300	41,500	42,800	40,750	38,750	31,800	30,050	24,450	21,200
50.0			36,400	36,400	37,650	36,900	36,800	34,800	28,800	30,050	24,450	21,200
55.0			31,500	31,700	32,950	32,100	31,950	31,900	26,300	29,400	24,450	21,200
60.0				27,650	28,850	28,000	28,750	28,550	24,100	27,350	24,150	21,200
65.0				25,350	25,450	24,650	25,400	25,200	22,200	24,500	22,150	20,600
70.0				17,600	22,600	22,150	22,500	22,350	20,500	21,650	20,350	19,300
75.0					20,200	19,750	20,450	19,950	19,050	19,250	18,800	18,100
80.0					19,500	17,800	18,400	18,450	17,450	18,050	17,400	17,000
85.0						16,900	16,700	16,750	15,800	16,700	15,950	15,800
90.0						15,750	15,150	15,200	14,600	15,150	14,700	14,550
95.0							13,050	13,750	13,850	13,750	13,350	13,200
100.0								12,800	12,650	13,000	12,100	12,000
105.0								11,200	11,550	11,900	11,050	10,900
110.0									10,600	10,950	10,100	9970
115.0									9750	10,050	9220	9100
120.0										9290	8430	8310
125.0										8570	7710	7590
130.0											7610	6930
135.0											7000	6320
140.0											6450	5760
145.0												5370
150.0												4900
155.0												4460
160.0												3930

\*Requires special equipment.

THIS CHART IS ONLY A GUIDE AND SHOULD NOT BE USED TO OPERATE THE CRANE.

The individual crane's load chart, operating instructions and other instructional plates must be read and understood prior to operating the crane.

# Load chart

## Main boom

 36.6 ft - 169.3 ft  
Fixed lengths

 36,000 lb

 100%  
23 ft

 360°



Pounds x 1000

Feet	36.6	49.7-50.1	61.6 - 63.6	75.2 - 77.4	88.1-90.3	100.8 - 103.0	111.4-114.4	124.6-125.8	130.0-133.7	147.3-153.3	160.9-165.0	169.3
9.0	178,000	164,000	160,000	129,000								
10.0	168,000	158,000	146,000	128,500								
12.0	150,500	148,500	135,500	123,500	94,650							
15.0	130,000	131,000	123,500	114,000	94,650	75,000						
20.0	102,000	103,500	104,000	99,950	93,900	73,550	58,050	45,800	40,950			
25.0	79,700	81,350	81,950	81,550	82,800	71,000	58,050	45,800	40,950	30,050		
30.0		64,600	64,900	66,500	65,600	62,850	56,600	45,800	39,550	30,050	24,450	21,200
35.0		52,700	52,150	53,650	52,800	54,200	50,350	45,800	35,300	30,050	24,450	21,200
40.0		43,300	44,350	44,200	45,400	44,600	44,450	43,550	35,300	30,050	24,450	21,200
45.0			36,750	36,600	37,900	37,000	36,800	37,550	31,800	30,050	24,450	21,200
50.0			30,850	32,300	32,050	31,250	31,950	31,750	28,800	30,050	24,450	21,200
55.0			27,450	27,800	27,450	26,900	27,700	27,150	26,300	26,400	24,450	21,200
60.0				24,150	23,800	23,300	24,050	23,800	23,050	23,600	23,200	21,200
65.0				21,150	22,300	21,350	21,050	21,150	20,250	21,000	20,300	20,400
70.0				15,250	19,800	19,250	18,700	18,650	18,850	18,550	18,100	17,950
75.0					17,700	17,150	16,950	16,700	17,050	16,750	16,150	16,050
80.0					16,000	15,450	15,200	14,900	15,300	15,000	14,400	14,250
85.0						13,900	13,650	13,400	13,750	13,450	12,850	12,750
90.0						12,550	12,300	12,050	12,400	12,100	11,550	11,400
95.0						10,750	11,150	10,850	11,200	10,950	10,350	10,250
100.0							10,100	9850	10,200	9910	9330	9210
105.0							9240	8920	9270	8980	8400	8280
110.0								8090	8430	8140	7570	7450
115.0								7,40	7680	7380	6820	6700
120.0									6990	6700	6130	6010
125.0									6380	6080	5510	5390
130.0										5510	4950	4820
135.0										4990	4430	4300
140.0										4510	3950	3830
145.0											3510	3380
150.0											3100	2980
155.0											2730	2600
160.0												2260

THIS CHART IS ONLY A GUIDE AND SHOULD NOT BE USED TO OPERATE THE CRANE.

The individual crane's load chart, operating instructions and other instructional plates must be read and understood prior to operating the crane.

# Load chart

## Main boom

 36.6 ft - 169.3 ft  
Fixed lengths
  26,000 lb
  100%  
23 ft
  360°



Pounds x 1000

Feet	36.6	49.7-50.1	61.6 - 63.6	75.2 - 77.4	88.1-90.3	100.8 - 103.0	111.4-114.4	124.6-125.8	130.0-133.7	147.3-153.3	160.9-165.0	169.3
9.0	173,500	164,000	152,500	129,000								
10.0	163,500	158,000	146,000	128,500	95,450							
12.0	146,500	147,500	135,500	123,500	94,350	74,550						
15.0	126,000	127,500	123,500	114,000	94,250	74,550	57,500					
20.0	97,050	98,600	99,200	98,700	93,900	73,150	57,500	45,450	40,950	29,800	24,150	
25.0	74,900	76,250	76,600	76,850	77,350	71,000	57,500	45,450	40,950	29,800	24,150	21,050
30.0		59,550	58,950	60,550	59,650	61,100	56,500	45,450	39,550	29,800	24,150	21,050
35.0		46,550	47,600	47,400	48,850	47,850	47,700	45,400	35,300	29,800	24,150	21,050
40.0		37,450	37,750	39,350	39,050	38,450	38,900	38,650	35,300	29,800	24,150	21,050
45.0			32,100	32,450	32,050	31,550	32,000	31,750	31,250	29,800	24,150	21,050
50.0			26,900	27,250	27,300	26,600	26,800	27,250	26,100	27,100	24,150	21,050
55.0			22,850	23,200	24,400	23,800	23,500	23,200	23,600	23,100	22,450	21,050
60.0				20,050	21,150	20,600	20,300	20,000	20,400	20,050	19,400	19,250
65.0				17,450	18,550	18,000	17,700	17,400	17,800	17,450	17,000	16,850
70.0				11,850	16,450	15,900	15,650	15,350	15,750	15,450	14,850	14,700
75.0					14,600	14,100	13,850	13,550	13,950	13,650	13,050	12,900
80.0					13,050	12,750	12,800	12,000	12,400	12,100	11,500	11,350
85.0						12,000	11,800	10,700	11,050	10,750	10,150	10,050
90.0						10,850	10,600	9530	9890	9600	9010	8890
95.0						8930	9610	8510	8860	8570	7990	7860
100.0							8700	7600	7950	7660	7080	6960
105.0							7900	6790	7140	6850	6270	6150
110.0								6070	6410	6120	5550	5430
115.0								5420	5750	5460	4890	4770
120.0									5160	4870	4300	4180
125.0									4630	4320	3760	3640
130.0										3830	3270	3150
135.0										3380	2810	2690
140.0										2960	2400	2280
145.0										2590	2020	1890
150.0											1660	1540
155.0											1340	1210

THIS CHART IS ONLY A GUIDE AND SHOULD NOT BE USED TO OPERATE THE CRANE.

The individual crane's load chart, operating instructions and other instructional plates must be read and understood prior to operating the crane.

# Load chart

## Main boom

 36.6 ft - 169.3 ft  
Fixed lengths

 16,000 lb

 100%  
23 ft

 360°



Pounds x 1000

Feet	36.6	49.7-50.1	61.6 - 63.6	75.2 - 77.4	88.1-90.3	100.8 - 103.0	111.4-114.4	124.6-125.8	128.5-133.7	147.3-153.3	160.9-165.0	169.3
9.0	168,500	164,000	152,500	129,000								
10.0	159,000	158,000	146,000	128,500	95,450							
12.0	142,000	143,500	135,500	123,500	94,350	74,550						
15.0	122,500	123,500	123,000	114,000	94,250	74,550	57,500	45,450				
20.0	92,000	93,550	94,150	93,650	93,900	73,150	57,500	45,450	40,950	29,800	24,150	
25.0	67,450	69,850	69,150	70,850	69,900	71,000	57,500	45,450	40,950	29,800	24,150	21,050
30.0		51,050	52,200	51,950	53,650	52,450	52,250	45,450	40,950	29,800	24,150	21,050
35.0		38,900	39,700	41,050	40,600	39,950	40,900	40,200	39,550	29,800	24,150	21,050
40.0		30,500	32,150	32,550	32,150	31,750	32,450	32,550	31,300	29,800	24,150	21,050
45.0			26,150	26,500	27,800	27,150	26,850	26,500	26,950	26,400	24,150	21,050
50.0			21,700	22,050	23,300	22,650	22,400	22,050	22,500	22,100	21,450	21,050
55.0			18,300	18,650	19,800	19,250	19,200	18,650	19,050	18,700	18,000	17,850
60.0				16,100	17,150	16,850	17,150	16,000	17,050	16,100	15,450	15,350
65.0				13,900	14,900	15,250	15,000	13,800	14,800	13,900	13,250	13,150
70.0				8,470	13,050	13,350	13,150	11,950	12,950	12,050	11,450	11,300
75.0					11,500	11,800	11,600	10,450	11,400	10,500	9910	9790
80.0					10,150	10,450	10,250	9130	10,050	9200	8600	8470
85.0						9340	9110	7990	8940	8060	7470	7340
90.0						8340	8110	6990	7940	7060	6480	6350
95.0						6550	7230	6120	7060	6190	5610	5480
100.0							6450	5350	6280	5410	4830	4710
105.0								5770	4660	5580	4720	4020
110.0									4050	4960	4100	3410
115.0									3490	4400	3540	2850
120.0										3900	3030	2340
125.0										2870	2570	1890
130.0											2150	1470
135.0											1770	1080
140.0											1420	
145.0											1100	

THIS CHART IS ONLY A GUIDE AND SHOULD NOT BE USED TO OPERATE THE CRANE.

The individual crane's load chart, operating instructions and other instructional plates must be read and understood prior to operating the crane.

# Load chart

## Main boom

 36.6 ft - 169.3 ft  
Fixed lengths

 6000 lb

 100%  
23 ft

 360°



Pounds x 1000

Feet	36.6	49.7-50.1	61.6 - 63.6	75.2 - 77.4	88.1-90.3	100.8 - 103.0	111.4-114.4	125.0-128.5	136.4-139.9	148.1-153.3	160.9-165.0	169.3
9.0	163,500	164,000	152,500	129,000								
10.0	154,000	155,000	146,000	128,500								
12.0	138,000	139,000	135,500	123,500	94,650							
15.0	118,000	119,500	120,000	114,000	94,650	75,000						
20.0	84,400	85,800	86,150	88,000	86,950	73,550	58,050	45,800				
25.0	55,950	58,750	60,100	59,850	61,850	60,450	58,050	45,800	37,900	30,050		
30.0		41,150	43,050	43,500	43,000	42,300	43,350	42,600	37,900	30,050	24,450	21,200
35.0		30,450	32,200	32,650	34,100	33,350	33,000	31,900	31,850	30,050	24,450	21,200
40.0		23,500	25,150	25,550	26,900	26,200	26,000	25,050	26,200	25,650	24,450	21,200
45.0			20,200	20,750	21,850	21,850	21,950	21,700	21,200	20,650	19,950	19,750
50.0			16,600	17,100	18,100	18,450	18,200	18,000	17,500	17,100	16,450	16,300
55.0			13,750	14,250	15,300	15,650	15,400	15,250	14,750	14,250	13,600	13,450
60.0				12,000	13,050	13,350	13,150	12,950	12,500	12,000	11,350	11,250
65.0				10,150	11,200	11,500	11,300	11,100	10,650	10,150	9560	9430
70.0				5070	9660	9990	9760	9580	9130	8670	8050	7920
75.0					8370	8690	8460	8290	7850	7380	6780	6650
80.0					7280	7580	7360	7190	6750	6290	5700	5570
85.0						6630	6400	6230	5800	5350	4760	4630
90.0						5800	5570	5400	4970	4530	3940	3820
95.0						4160	4840	4670	4240	3800	3220	3100
100.0							4200	4030	3600	3160	2590	2460
105.0							3640	3450	3030	2590	2020	1890
110.0								2940	2510	2080	1510	1390
115.0								2480	2050	1610	1050	
120.0									1630	1200		
125.0									1250			

THIS CHART IS ONLY A GUIDE AND SHOULD NOT BE USED TO OPERATE THE CRANE.

The individual crane's load chart, operating instructions and other instructional plates must be read and understood prior to operating the crane.

# Working range

Main boom and manually offsettable extension

36.6 ft - 169.3 ft main boom, 34.5 ft - 57.6 ft manually offsettable extension and 26.2 ft insert

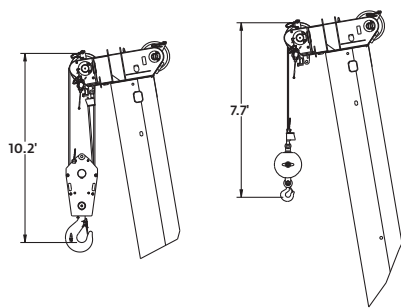
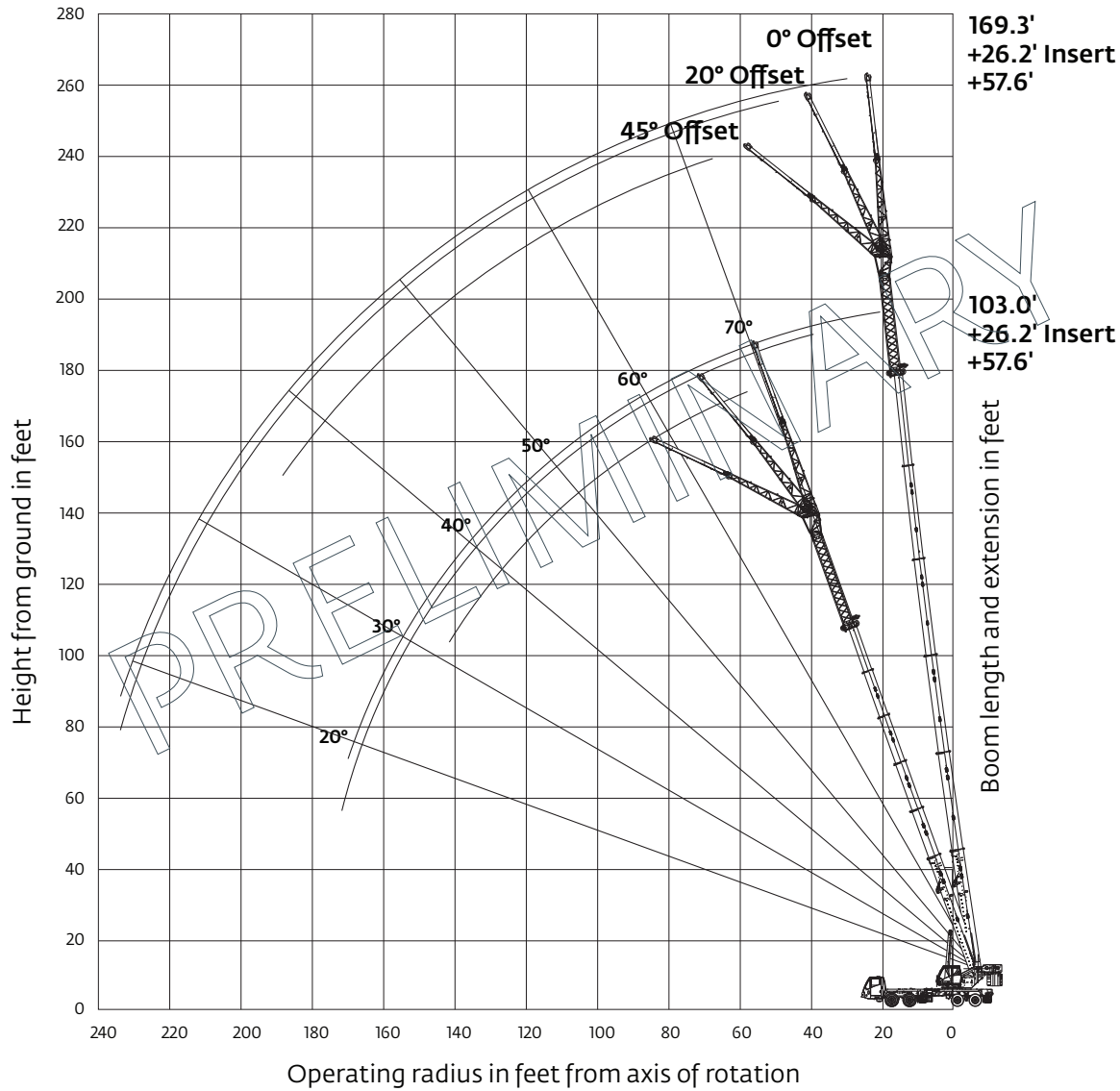

Dimensions are for the largest Grove furnished hook block and overhaul ball, with anti-two block activated.

THIS CHART IS ONLY A GUIDE AND SHOULD NOT BE USED TO OPERATE THE CRANE.  
The individual crane's load chart, operating instructions and other instructional plates must be read and understood prior to operating the crane.



# Load chart

## Integrated heavy duty jib

-   
**169.3 ft**  
Fixed lengths
-   
**34.5 ft - 57.6 ft**  
Manual offsettable swingaway
-   
**26.2 ft**  
Insert
-   
**48,500 lb**
-   
**100%**  
23 ft
-   
**360°**

  **Pounds x 1000**

Feet	34.5 ft			57.6 ft			83.8 ft		
	0°	20°	45°	0°	20°	45°	0°	20°	45°
35	10,650								
40	10,650								
45	10,650			7340					
50	10,650	10,800		7340					
55	10,650	10,800	11,100	7340			4290		
60	10,650	10,800	11,100	7340	7960		4290		
65	10,650	10,800	11,100	7340	7960		4290		
70	10,650	10,800	11,100	7340	7960		4290	4770	
75	10,650	10,800	11,100	7340	7930		4290	4770	
80	10,650	10,800	11,100	7340	7740	6160	4290	4770	
85	10,650	10,800	11,000	7340	7560	6090	4290	4770	
90	10,650	10,800	10,800	7340	7390	6030	4290	4770	
95	10,350	10,150	10,200	7340	7230	5970	4290	4770	3710
100	9720	9560	9660	7340	7080	5910	4290	4770	3610
105	9130	9010	9120	7340	6930	5860	4290	4760	3510
110	8590	8500	8620	7340	6800	5820	4290	4650	3420
115	8090	8030	8150	7340	6680	5780	4290	4500	3330
120	7630	7590	7710	7340	6560	5740	4290	4360	3250
125	7070	7180	7300	7340	6450	5710	4290	4230	3160
130	6400	6790	6910	7110	6350	5690	4290	4100	3090
135	5790	6170	6400	6770	6250	5670	4290	3980	3010
140	5230	5580	5770	6450	6160	5660	4290	3860	2940
145	4710	5030	5180	6070	6080	5650	4290	3760	2870
150	4230	4510	4630	5580	5920	5650	4210	3650	2810
155	3780	4040	4120	5130	5660	5650	4070	3550	2750
160	3350	3590	3640	4710	5200	5510	3870	3460	2690
165	2930	3150		4320	4770	5030	3660	3370	2630
170	2530	2720		3950	4360	4580	3460	3280	2580
175	2160	2310		3610	3990	4160	3260	3200	2530
180	1810	1930		3290	3630	3750	2940	3120	2480
185	1480			2990	3290	3360	2630	3050	2430
190	1170			2710	2970		2330	2970	2390
195				2450	2670		2060	2710	2350
200				2170	2380		1790	2410	2310
205				1910	2060		1550	2120	2270
210					1750		1310	1850	2170
215								1590	1860

*THIS CHART IS ONLY A GUIDE AND SHOULD NOT BE USED TO OPERATE THE CRANE.  
The individual crane's load chart, operating instructions and other instructional plates must be read and understood prior to operating the crane.*

# Working range

Integrated heavy duty jib

36.6 ft - 169.3 ft main boom and integrated heavy duty jib

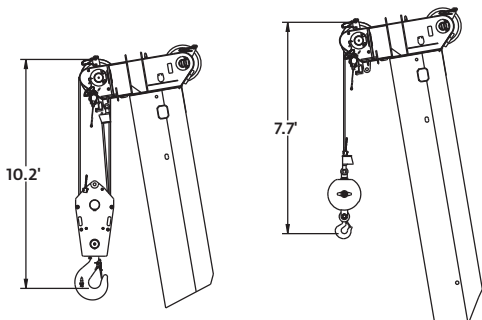
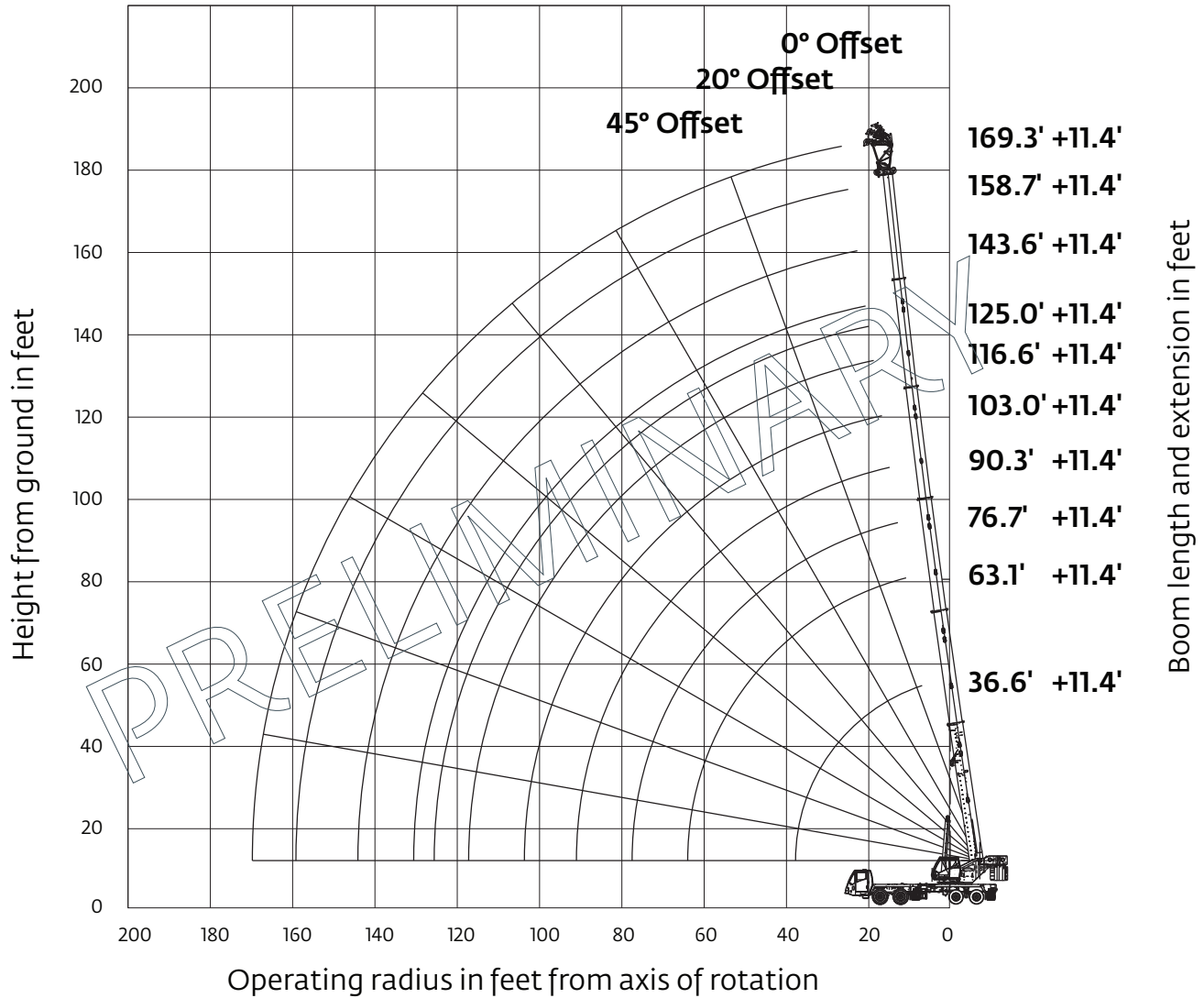

Dimensions are for the largest Grove furnished hook block and overhaul ball, with anti-two block activated.

*THIS CHART IS ONLY A GUIDE AND SHOULD NOT BE USED TO OPERATE THE CRANE.  
The individual crane's load chart, operating instructions and other instructional plates must be read and understood prior to operating the crane.*

# Load chart

## Integrated heavy duty jib

-   
169.3 ft  
Fixed lengths
-   
11.4 ft  
Integrated heavy duty jib
-   
48,500 lb
-   
100%  
23 ft
-   
360°



 Pounds x 1000

Feet	103.0 ft			143.0 ft			169.3 ft		
	0°	20°	45°	0°	20°	45°	0°	20°	45°
10	55,600	51,050							
12	55,600	51,050	44,700						
15	55,600	51,050	44,700	24,900					
20	55,600	51,050	44,700	24,900	23,050				
25	55,600	51,050	44,700	24,900	23,050	20,250			
30	55,600	50,650	44,700	24,900	23,050	20,250	16,700	15,450	13,350
35	52,350	45,800	41,150	24,900	23,050	20,250	16,700	15,450	13,350
40	46,850	41,800	37,950	24,900	23,050	20,250	16,700	15,450	13,350
45	42,300	38,450	35,250	24,900	23,050	20,250	16,700	15,450	13,350
50	36,250	35,550	32,850	24,100	23,050	20,250	16,700	15,450	13,350
55	31,350	31,750	30,800	22,000	21,500	20,250	16,700	15,450	13,350
60	27,400	27,750	28,100	20,200	19,800	19,300	16,700	15,450	13,350
65	24,150	24,450	24,750	18,600	18,300	18,050	16,700	15,450	13,350
70	21,350	21,650	21,900	17,250	16,950	16,750	16,700	15,450	13,350
75	19,050	19,250	19,500	16,000	15,750	15,600	16,350	15,450	13,350
80	17,150	17,250	17,500	14,900	14,700	14,550	15,250	15,050	13,350
85	15,400	15,600	15,800	13,950	13,750	13,650	14,300	14,100	13,350
90	13,950	14,100	14,250	13,050	12,900	12,800	13,450	13,300	13,150
95	12,650	12,800	12,900	12,150	12,100	12,050	12,350	12,500	12,400
100	11,500	11,650	11,700	11,300	11,350	11,350	11,200	11,400	11,600
105	10,550	10,650	10,700	10,450	10,600	10,650	10,150	10,300	10,500
110				9520	9670	9810	9210	9380	9550
115				8670	8810	8940	8360	8520	8680
120				7910	8040	8150	7590	7740	7890
125				7220	7340	7440	6890	7030	7170
130				6590	6700	6780	6250	6380	6510
135				6030	6120	6190	5670	5790	5900
140				5520	5590	5650	5130	5250	5350
145				5070	5130	5160	4640	4750	4840
150							4190	4280	4360
155							3770	3860	3930
160							3390	3460	3520
165							3040	3100	3150
170							2730	2780	2810

THIS CHART IS ONLY A GUIDE AND SHOULD NOT BE USED TO OPERATE THE CRANE.

The individual crane's load chart, operating instructions and other instructional plates must be read and understood prior to operating the crane.

# Specifications

## Super Structure

### Boom

11,2 m - 51,6 m (36.6 ft - 169.3 ft) six-section greaseless MEGAFORM™ boom with TWIN-LOCK™ pinning system. Maximum tip height: 54,8 m (179.8 ft).

### Boom nose

Five nylatron sheaves, mounted with removable pin-type rope guards. Quick Reeve boom nose. Removable auxiliary boom nose with removable pin type rope guard.

### Boom elevation

Single lift cylinder with integrated valve provides boom angle from -3° to +82°.

### \*Optional offsettable lattice extensions

10,5 m - 17,6 m (34.5 ft - 57.6 ft) bi-fold lattice swingaway extension manually offset at 0°, 20°, and 45°. Maximum tip height: 72,3 m (237.3 ft).

10,5 m - 17,6 m (34.5 ft - 57.6 ft) bi-fold lattice swingaway extension hydraulically offset from 0° - 45°. Controlled from the crane cab. Maximum tip height: 72,3 m (237.3 ft).

10,5 m - 17,6 m (34.5 ft - 57.6 ft) bi-fold lattice swingaway extension with integrated 3,5 m (11.4 ft) heavy duty jib, manually offset at 0°, 20°, and 45°. Maximum tip height: 72,3 m (237.3 ft).

10,5 m - 17,6 m (34.5 ft - 57.6 ft) bi-fold lattice swingaway extension with integrated 10 ft (3 m) heavy duty jib, hydraulically offset from 0° - 45°. Controlled from the crane cab. Maximum tip height: 72,3 m (237.3 ft).

### \* Optional lattice insert

One 8 m (26.2 ft) insert for use with lattice swingaway extension to increase length up to 25,6 m (83.8 ft). Maximum tip height: 80,3 m (263.4 ft)

### Rated Capacity Limiter and anti-two block system

Load moment and anti-two block system with audio/visual warning and control lever lockout provides electronic display of boom angle, length, radius, tip height, relative load moment, maximum permissible load, load indication, slew angle and warning of impending two-block condition.

### Crane Control System (CCS)

Full electronic control of all crane movements using electrical control allowing user customization of levels and response. Integrated with the RCL and engine management system by CAN-BUS. Full-color high resolution graphic display.

### Cab

All aluminum construction cab with acoustical lining tilts hydraulically to +20° and includes tinted safety glass, air conditioning,

adjustable operator's seat with hydraulic suspension, hinged front (with wiper) and rear windows, sun visor and window shade. Other features include diesel heater/defroster, stereo radio/disc player, armrest integrated crane controls, and ergonomically arranged instrumentation.

### Swing

Two planetary gearboxes with axial piston fixed displacement motors. Infinitely variable to 1.9 rpm. Spring-applied park brakes and hydraulic service brakes.

### Counterweight

7258 kg (16,000 lb) consisting of multiple sections with hydraulic installation/removal system operated from the cab.

\*Optional "Heavy Lift" counterweight package consisting of (2) 4636 kg (10,000 lb) sections in addition to standard, for a total of 16 329 kg (36,000 lb).

\*Optional "XL" counterweight package consisting of (2) 1814 kg (4000 lb) and (2) 1021 kg (2250 lb) wing sections in addition to standard and "Heavy Lift" package, for a total of 22 000 kg (48,500 lb).

\*Optional "Special XL" counterweight package consisting of two 1814 kg (4000 lb) and two 1021 kg (2250 lb) wing sections in addition to modified standard counterweight package (a 907 kg (2000 lb) slab and a 1360 kg (3,000lb) slab in lieu of one 2268 kg (5000 lb) slab and "Heavy Lift" package, for a total of 22 000 kg (48,500 lb).

### Hydraulic system

Two load-sensing axial piston variable displacement pump (load sensing) with power limiting control and one gear pump for slewing and steering. Dual fan electric oil cooler. On screen display of hydraulic oil temperature. Tank capacity 658 liters (174 gallons).

### Hoist

Main and auxiliary hoists are powered by axial piston motors with planetary gears and brakes. "Thumb-thumper" hoist drum rotation indicator alerts operator of hoist movement. Standard minimum wrap indication with lock-out.

Hoist line pull:

1st Layer: 10 900 kg (24,000 lb)

3rd Layer: 9250 kg (20,400 lb)

5th Layer: 8000 kg (17,700 lb)

Maximum line speed:

113 m/min (370 fpm)

Maximum permissible line pull:

7784 kg (17,160 lb) 35X7 Class

Rope diameter: 19 mm (3/4 in)

Rope length main hoist : 250 m (820 ft)

Rope length auxiliary hoist : 177 m (581 ft)

Maximum rope storage: 292 m (960 ft)

### Cameras

Standard back-up, right-side and hoist cameras.

## Carrier



### Chassis

Torsionally rigid frame, four-axle carrier, fabricated from high strength, low alloy steel with towing and tie-down lugs.



### Outrigger system

Four hydraulic telescoping, two-stage, double box beam outriggers and integral holding valves.

Quick release type outrigger floats 500 mm (20 in) diameter.

Four position setting with fully extended, 79%, 57%, and fully retracted capacities. Fifth (5th) front jack with sliding self-storing pad and automatic first-retract.

Outrigger Monitoring System standard (required for North America and Canada).

Maximum outrigger pad load: 49,900 kg (110,000 lb)



### Outrigger controls

Located in the superstructure cab and on either side of carrier. Crane level indicators located at all stations.

Auto leveling and wireless remote control standard.



### Engine

Cummins ISX 12 six-cylinder, turbo charged and after cooled diesel engine. 12 L 336 kW (450 bhp) at 1800 rpm. Maximum torque 2102 Nm (1550 lb-ft) at 1400 rpm. "On Highway" EPA, CARB compliant.

Equipped with engine compression brake, ether start aid and 110 volt blackheater.

Fuel Requirement: Maximum of 15 ppm sulfur content (Ultra Low Sulfur Diesel). Diesel exhaust fluid required.



### Fuel tank capacity

376 L (100 gal)



### Transmission

Roadranger 11 speeds forward, 3 reverse, manual.

Optional automated Eaton Fuller Ultrashift® PLUS Transmission



### Steering

Front axles, single circuit, mechanical steering with hydraulic power assist. Turning radius: 13,8 m (45.4 ft).



### Axles

**Front:** (2) tube-type steering axles, 2,12 m (83.4 in) track.

**Rear:** (2) single reduction drive axles, 1,89 m (74.5 in) track. Inter-axle differential locks.

Drive: 8 x 4 x 4.



### Brakes

S-cam, dual air split system operating on all wheels. Spring-applied, air released parking brake acting on rear axles. Air dryer. ABS with traction control.



### Suspension

**Front:** Walking beam with air bags and shock absorbers.

**Rear:** Walking beam with air bags and shock absorbers.



### Tires

**Front:** 445/65R 22.5 tubeless, mounted on aluminum disc wheels.

**Rear:** 315/80R 22.5 tubeless, mounted on aluminum disc wheels.



### Lights

Lighting package including turn indicators, head, tail, brake, and hazard warning lights.



### Cab

Single-driver design, aluminum fabricated with acoustical lining and tinted safety glass. Air conditioning. Fabric covered seat with air adjustment. Driving controls and engine instrumentation including tilt telescope multifunction steering wheel, tachometer, speedometer, trip meter, voltmeter, water temp., oil, fuel level, air pressure gauge, engine high temp./low oil pressure A/V warning. Other standard items include display for back-up and passenger side cameras, hot water heater/defroster, electric windshield wash/wipe, fire extinguisher, wireless rigging remote with battery charging station, seat belt and door lock.



### Electrical system

Four maintenance-free batteries provide 24 V electrical system. Standard lockable battery disconnect.



### Maximum speed

105 kph (65 mph)



### Gradeability (theoretical)

70%, 1st gear





































## Miscellaneous standard equipment

Aluminum fenders with rear storage compartments; dual rear view mirrors; electronic back-up alarm; sling/tool box; tire inflation kit; air cleaner restriction indicator; headache ball stowage tray; air conditioning; air horn; hoist access platform

## \*Optional equipment

- Auxiliary Lighting and Convenience Package: Includes amber strobe light for superstructure and carrier cab, and boom nose mounted, boom position indicator light (fully wired)
- Dual boom base mounted floodlights (manual or power-adjusted)
- Hook blocks
- Pintle hook (rear)
- Trailing Boom Package
- Steel outrigger pads
- Counterweight packages
- Tow cable
- Wind speed indicator
- Winterfront radiator cover
- Counterweight slings
- Cross axle differential locks
- Electric controlled 360° lock
- Rear counterweight stowage
- Single axis joysticks
- K-100™ synthetic rope
- Boom dolly camera
- CraneSTAR asset management system

# Symbols glossary

 Axles	 Counterweight	 Height (no max)	 Radius
 Boom	 Drive	 Heavy duty jib	 Outriggers
 Boom elevation	 Electrical system	 Hoist	 Rotation
 Boom extension	 Engine	 Hookblock	 Speed
 Boom length	 Extension	 Hydraulic system	 Steering
 Boom nose	 Frame	 Insert	 Suspension
 Brakes	 Fuel tank capacity	 Lights	 Swing
 Cab	 Gear	 Oil	 Tires
 Camera	 Grade	 Outrigger controls	 Transmission



## Manitowoc Cranes

### Regional headquarters

#### Americas

**Manitowoc, Wisconsin, USA**  
Tel: +1 920 684 6621  
Fax: +1 920 683 6277

**Shady Grove, Pennsylvania, USA**  
Tel: +1 717 597 8121  
Fax: +1 717 597 4062

#### Europe and Africa

**Dardilly, France - TOWERS**  
Tel: +33 (0)4 72 18 20 20  
Fax: +33 (0)4 72 18 20 00

**Wilhelmshaven, Germany - MOBILE**  
Tel: +49 (0) 4421 294 0  
Fax: +49 (0) 4421 294 4301

#### China

**Shanghai, China**  
Tel: +86 21 6457 0066  
Fax: +86 21 6457 4955

#### Middle East and Greater Asia-Pacific Singapore

Tel: +65 6264 1188  
Fax: +65 6862 4040

#### Dubai, UAE

Tel: +971 4 8862677  
Fax: +971 4 8862678/79



This document is non-contractual. Constant improvement and engineering progress make it necessary that we reserve the right to make specification, equipment, and price changes without notice. Illustrations shown may include optional equipment and accessories and may not include all standard equipment.